

© Binder GmbH 2017 Diese Zeichnung ist urheberrechtlich geschützt. Alle Rechte vorbehalten.

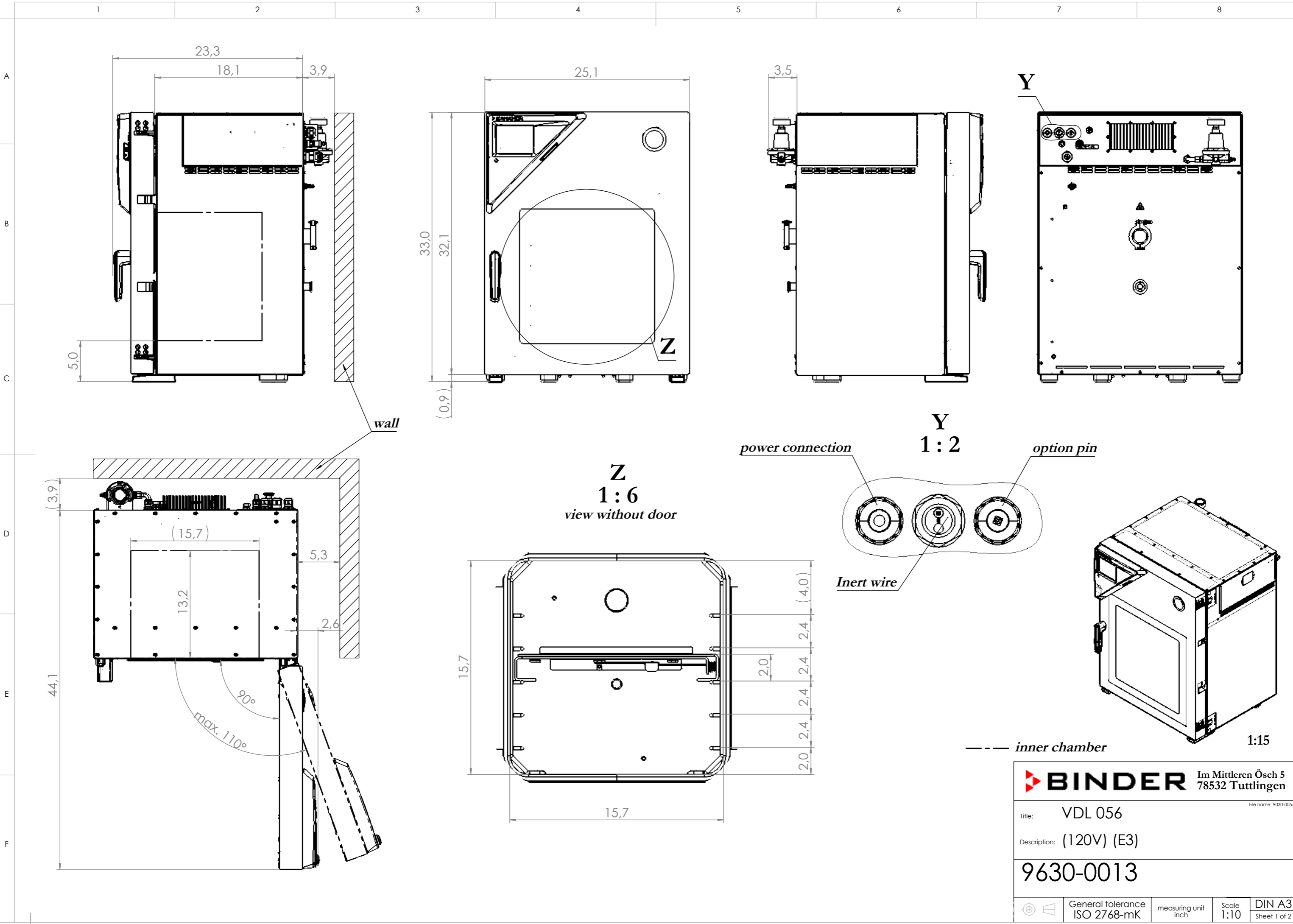

**Z**  
1:6  
view without door

**Y**  
1:2

power connection

option pin

Inert wire



--- inner chamber

1:15

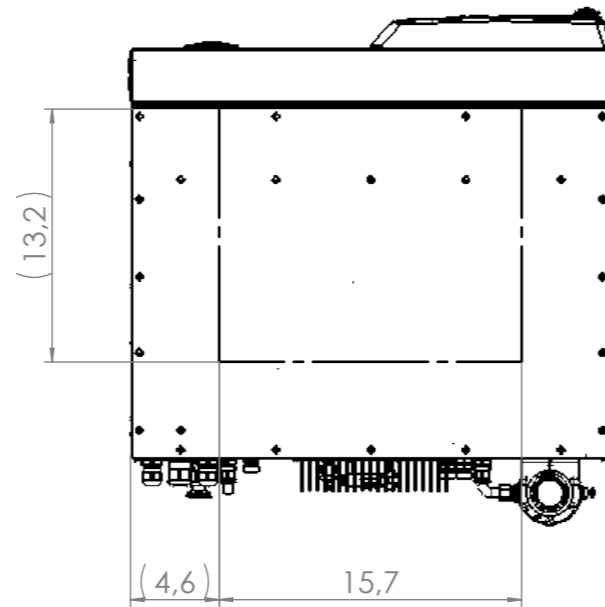
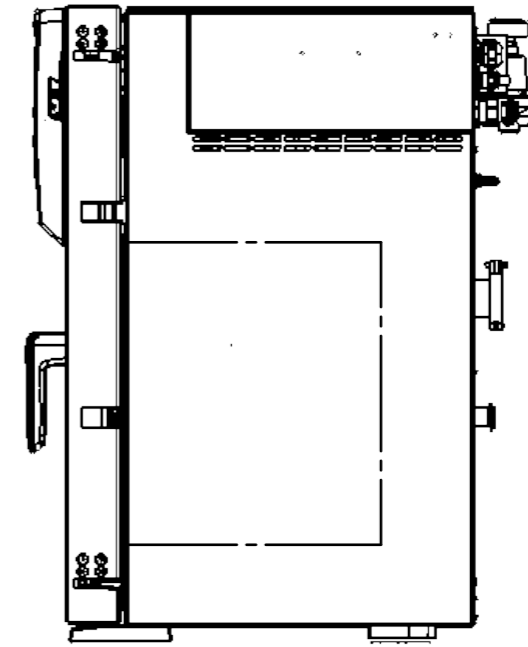
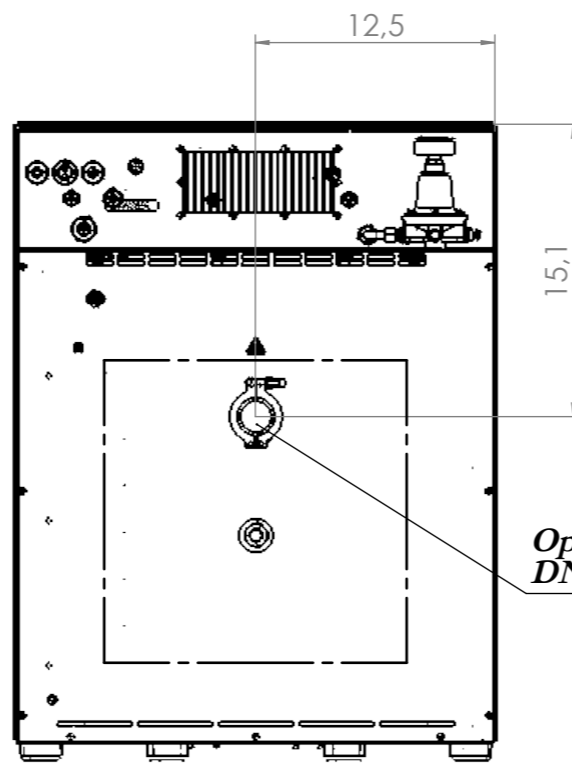
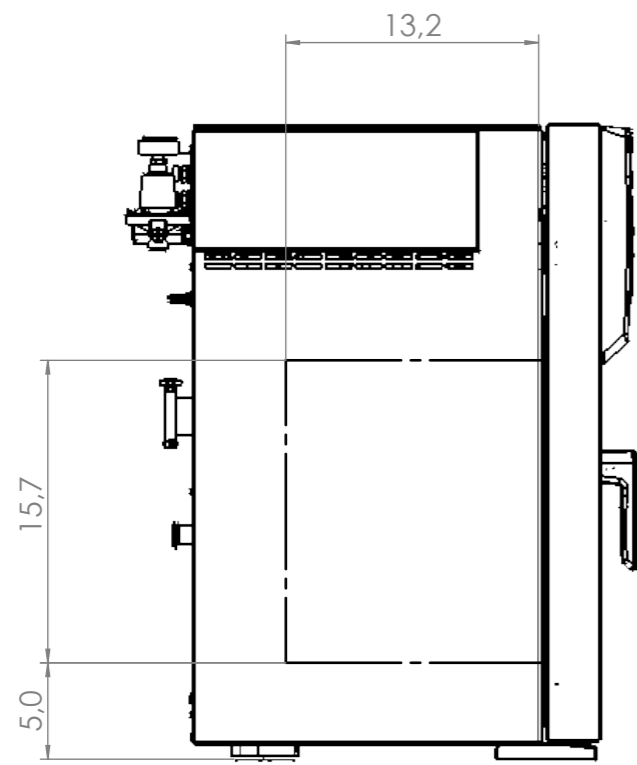
		Im Mittleren Ösch 5 78532 Tuttlingen		File name: 9030-0054
Title:		VDL 056		
Description:		(120V) (E3)		
9630-0013				
	General tolerance ISO 2768-mK	measuring unit inch	Scale 1:10	DIN A3 Sheet 1 of 2



--- inner chamber

 <b>Im Mittleren Ösch 5 78532 Tuttlingen</b>		<small>File name: 9030-0054</small>	
Title: VDL 056		Description: (120V) (E3)	
<h1>9630-0013</h1>			
 General tolerance ISO 2768-mK	measuring unit inch	Scale 1:10	DIN A3 Sheet 2 of 2