

Operating Manual

Translation of the original operating manual

BINDER ICH Q1B Light Module

**BINDER ICH Q1B Light Module
with Quantum Control LQC**

Accessory for KB PRO, KBF/KBF-UL, KBF PRO (E7)

Accessory	For chamber size	Art. no.
ICH Q1B Light module	260, 470	8012-2441
ICH Q1B Light module	720	8012-2442
ICH Q1B Light module with Quantum Control	260, 470	8012-2443
ICH Q1B Light module with Quantum Control	720	8012-2444

BINDER GmbH

- ▶ Address: Post office box 102, 78502 Tuttlingen, Germany ▶ Tel.: +49 7462 2005 0
- ▶ Fax: +49 7462 2005 100 ▶ Internet: <http://www.binder-world.com>
- ▶ Service Hotline: +49 7462 2005 555 ▶ Service Fax +49 7462 2005 93 555
- ▶ Service Hotline USA: +1 866 885 9794 or +1 631 224 4340 x3
- ▶ Service Hotline Asia Pacific: +852 390 705 04 or +852 390 705 03

Content

1. SAFETY	5
1.1 Personnel Qualification	5
1.2 Operating manual	5
1.3 Legal considerations	5
1.3.1 Intellectual property	6
1.4 Structure of the safety instructions in the operating manual	6
1.4.1 Signal word panel	6
1.4.2 Safety alert symbol	7
1.4.3 Pictograms	7
1.4.4 Word message panel structure	8
1.5 Localization / position of safety labels on the accessory	8
1.6 Type plate	9
1.7 UKCA Label	10
1.8 General safety instructions on installing and operating the BINDER ICH Q1B light module accessory	10
1.9 Intended use	11
1.10 Foreseeable Misuse	12
1.11 Residual Risks	13
1.12 Operating instructions	14
1.13 Measures to prevent accidents	14
2. DEVICE DESCRIPTION	15
2.1 Extension of the functionality of the KB PRO, KBF, and KBF PRO chambers with the ICH Q1B Light module accessory and with the ICH Q1B Light module with Quantum Control LQC	15
2.2 Description of the BINDER ICH Q1B Light module accessory and BINDER ICH Q1B Light module with Quantum Control LQC	16
2.3 Chamber overview: Cooling incubator/climate chamber with ICH Q1B light module	18
2.4 Chamber overview: ICH Q1B light box	19
2.5 Connection panel on the rear of the cooling incubator/climate chamber	20
3. SCOPE OF DELIVERY, TRANSPORTATION, STORAGE, AND INSTALLATION	21
3.1 Scope of delivery of the ICH Q1B light module	21
3.2 Scope of delivery of the ICH Q1B light module with Quantum Control	21
3.3 Unpacking, and checking equipment and completeness of delivery	21
3.4 Guidelines for safe transportation and storage	22
3.5 Location of installation and ambient conditions	22
4. INSTALLATION AND CONNECTIONS	24
4.1 Installation of the ICH Q1B light box on the cooling incubator/climate chamber	24
4.1.1 Installation of the mounting rails	24
4.1.2 Installing the ICH Q1B light box	25
4.1.3 Attaching the UVA warning sticker	26
4.2 Installing the light cassettes	26
4.3 Connecting the light cassettes to the ICH Q1B light box	27
4.4 Connecting the light sensors to the ICH Q1B light box (ICH Q1B light module with Quantum Control)	28
4.5 Inserting the silicone foam plugs	29
4.6 Establishing the data connection between the ICH Q1B light box and the cooling incubator/climate chamber	29
4.7 Electrical connection	29
5. FUNCTIONAL OVERVIEW OF THE MB2 CHAMBER CONTROLLER	31
5.1 Controller icons overview	33

6.	START UP	35
6.1	Turning on the cooling incubator/climate chamber	35
6.2	Controller settings upon start up	35
7.	FUNCTION OF LIGHT MEASUREMENT AND INTEGRATION: ICH Q1B LIGHT MODULE WITH QUANTUM CONTROL	36
7.1	Display of the instantaneous and the integrated values	36
7.2	Measurement of illumination intensity and temporal integration	36
8.	SET-POINT ENTRY IN “FIXED VALUE” OPERATING MODE	38
8.1	Set-point entry through the “Setpoints” menu	39
8.2	Direct setpoint entry via Normal display	40
8.3	Automatic correction of the actual value when turning on or off the illumination	40
8.4	Light commutation and special controller functions	40
9.	TIME PROGRAMS	41
9.1	Value entry for a program section	42
9.1.1	Light commutation and special controller functions	43
9.1.2	Setpoint entry	44
9.1.3	Tolerance range	45
10.	WEEK PROGRAMS	46
10.1	Value entry for a program section	46
10.1.1	Setpoint entry	46
10.1.2	Light commutation and special controller functions	46
11.	ALARM FUNCTIONS	47
11.1.1	Messages when reaching a dose target value – ICH Q1B light module with Quantum Control	47
11.1.2	Alarm messages	48
12.	ICH COMPLIANT ILLUMINATION ACCORDING TO CPMP/ICH/279/95 (Q1B).	49
12.1	Adjustable light cassettes	50
12.2	Characteristic features of the light sensors – ICH Q1B light module with Quantum Control	50
12.2.1	VIS sensor	50
12.2.2	UVA sensor	50
12.2.3	Spectral range	51
12.2.4	Spatial sensitivity	51
13.	CLEANING AND DECONTAMINATION	53
13.1	Cleaning	53
13.2	Decontamination / chemical disinfection	55
14.	MAINTENANCE AND SERVICE, TROUBLESHOOTING, REPAIR, TESTING... ..	56
14.1	General information, personnel qualification	56
14.2	Maintenance intervals, service	56
14.2.1	Replacement of the UVA fluorescent tubes	57
14.2.2	Replacement of the VIS LED boards	57
14.2.3	Calibrating the light sensors and adjusting the controller display (accessory with Quantum Control)	57
14.3	Troubleshooting	57
14.4	Sending the accessory back to BINDER GmbH	58
15.	DISPOSAL	58
15.1	Disposal of the transport packing	58
15.2	Decommissioning	58

15.3	Disposal of the accessory in the Federal Republic of Germany	59
15.4	Disposal of the accessory in the member states of the EU except for the Federal Republic of Germany.....	60
15.5	Disposal of the accessory in non-member states of the EU	61
16.	TECHNICAL DATA	61
17.	CERTIFICATES AND DECLARATIONS OF CONFORMITY.....	62
17.1	EU Declaration of Conformity.....	62
17.2	UKCA Declaration of Conformity	64
18.	CONTAMINATION CLEARANCE CERTIFICATE	65
18.1	For chambers located outside USA and Canada	65
18.2	For chambers located in USA and Canada	68

Dear customer,

For the correct operation of the chambers, it is important that you read this operating manual completely and carefully and observe all instructions as indicated. Failure to read, understand and follow the instructions may result in personal injury. It can also lead to damage to the chamber and/or poor equipment performance.

1. Safety

1.1 Personnel Qualification



The chamber must only be installed, tested, and started up by personnel qualified for assembly, startup, and operation of the chamber. Qualified personnel are persons whose professional education, knowledge, experience and knowledge of relevant standards allow them to assess, carry out, and identify any potential hazards in the work assigned to them. They must have been trained and instructed, and be authorized, to work on the chamber.

The chamber should only be operated by laboratory personnel especially trained for this purpose and familiar with all precautionary measures required for working in a laboratory. Observe the national regulations on minimum age of laboratory personnel.

1.2 Operating manual

This operating manual is part of the components of delivery. Always keep it handy for reference in the vicinity of the chamber. If selling the unit, hand over the operating manual to the purchaser.

To avoid injuries and damage observe the safety instructions of the operating manual. Failure to follow instructions and safety precautions can lead to significant risks.

	<div style="background-color: red; color: white; padding: 5px; text-align: center;">  DANGER </div> <p>Dangers due to failure to observe the instructions and safety precautions. Serious injuries and chamber damage. Risk of death.</p> <ul style="list-style-type: none"> ➤ Observe the safety instructions in this Operating Manual. ➤ Follow the operating procedures in this Operating Manual. ➤ Carefully read the complete operating instructions of the chamber prior to installing and using the chamber. ➤ Keep the operating manual for future reference
---	---

	<p>Make sure that all persons who use the chamber and its associated work equipment have read and understood the Operating Manual.</p>
---	--

This Operating Manual is supplemented and updated as needed. Always use the most recent version of the Operating Manual. When in doubt, call the BINDER Service Hotline for information on the up-to-date-ness and validity of this Operating Manual.

1.3 Legal considerations

This operating manual is for informational purposes only. It contains information for correct and safe installing, start-up, operation, decommissioning, cleaning and maintenance of the product. Note: the contents and the product described are subject to change without notice.

Understanding and observing the instructions in this operating manual are prerequisites for hazard-free use and safety during operation and maintenance. Images are to provide basic understanding. They may deviate from the actual version of the chamber. The actual scope of delivery can, due to optional or special design, or due to recent technical changes, deviate from the information and illustrations in these instructions this operating manual. In no event shall BINDER be held liable for any damages, direct or incidental arising out of or related to the use of this manual.

This operating manual cannot cover all conceivable applications. If you would like additional information, or if special problems arise that are not sufficiently addressed in this manual, please ask your dealer or contact us directly, e.g. by phone at the number located on page one of this manual

Furthermore, we emphasize that the contents of this operating manual are not part of an earlier or existing agreement, description, or legal relationship, nor do they modify such a relationship. All obligations on the part of BINDER derive from the respective purchase contract, which also contains the entire and exclusively valid statement of warranty administration and the general terms and conditions, as well as the legal regulations valid at the time the contract is concluded. The statements in this manual neither augment nor restrict the contractual warranty provisions.

1.3.1 Intellectual property

Trademark Information: All BINDER trademarks relating to products or service, as well as trade names, logos and product names used on the website, products and documents of BINDER company are trademarks or registered trademarks of BINDER company (including BINDER GmbH, BINDER Inc.) in the U.S. and other countries and communities of states. This includes word marks, position marks, word/figurative marks, design configurations, figurative marks, and design patents.

Patent Information: BINDER products, categories of products, and accessories may be covered by one or more patents and/or utility models in the U.S. and other countries and communities of states. This information is provided to satisfy the virtual patent marking provisions of various jurisdictions, in particular it is intended to serve as notice under 35 U.S.C. § 287(a). Products and services listed on the BINDER website may be sold individually or as part of a combination product. Additional patent applications may also be pending in the U.S. and other countries and communities of states.

Please visit www.binder-world.com for more information.

1.4 Structure of the safety instructions in the operating manual

In this operating manual, the following safety definitions and symbols indicate dangerous situations following the harmonization of ISO 3864-2 and ANSI Z535.6.

1.4.1 Signal word panel

Depending on the probability of serious consequences, potential dangers are identified with a signal word, the corresponding safety color, and if appropriate, the safety alert symbol.



Indicates an imminently hazardous situation that, if not avoided, will result in death or serious (irreversible) injury.



Indicates a potentially hazardous situation which, if not avoided, could result in death or serious (irreversible) injury.



Indicates a potentially hazardous situation which, if not avoided, may result in moderate or minor (reversible) injury.

NOTICE

Indicates a potentially hazardous situation which, if not avoided, may result in damage to the product and/or its functions or of a property in its proximity.

















1.4.2 Safety alert symbol



Use of the safety alert symbol indicates a **risk of injury**.

Observe all measures that are marked with the safety alert symbol in order to avoid death or injury.

1.4.3 Pictograms

Warning signs			
 Electrical hazard	 Hot surface	 Explosive atmosphere	 UV light hazard
 Risk of corrosion and / or chemical burns	 Harmful substances	 Biohazard	 Pollution Hazard
Mandatory action signs			
 Mandatory regulation	 Read operating instructions	 Disconnect the power plug	 Environment protection
 Wear protective gloves	 Wear safety goggles		
Prohibition signs			
 Do NOT touch	 Do NOT spray with water		



Information to be observed in order to ensure optimum function of the product.

1.4.4 Word message panel structure

Type / cause of hazard.





Possible consequences.

- ∅ Instruction how to avoid the hazard: prohibition
- Instruction how to avoid the hazard: mandatory action.

Observe all other notes and information not necessarily emphasized in the same way, in order to avoid disruptions that could result in direct or indirect injury or property damage.

1.5 Localization / position of safety labels on the accessory

The following labels are located on the chamber:

Pictograms (warning signs)	
	Hot surface (on the cooling incubator/climate chamber)
	UV light hazard (on the ICH Q1B light box)
	Risk of injury. Observe the safety instructions in the operating manual (on the type plate of the ICH Q1B light box)
Information	
 <p>MySupport.binder-world.com</p>	QR-Code and URL to contact the BINDER Support Center

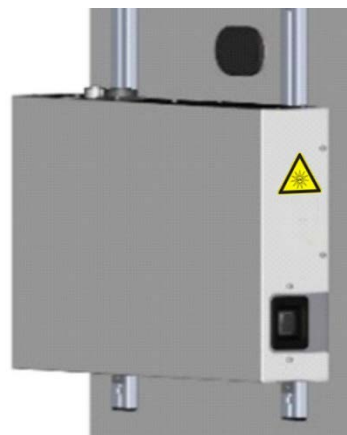

Figure 1: Position of safety label on the right side of the ICH Q1B light box



Keep safety labels complete and legible.

Replace safety labels that are no longer legible. Contact BINDER Service for these replacements.

1.6 Type plate

The type plate is located bottom right-hand on the front of the ICH Q1B light box.

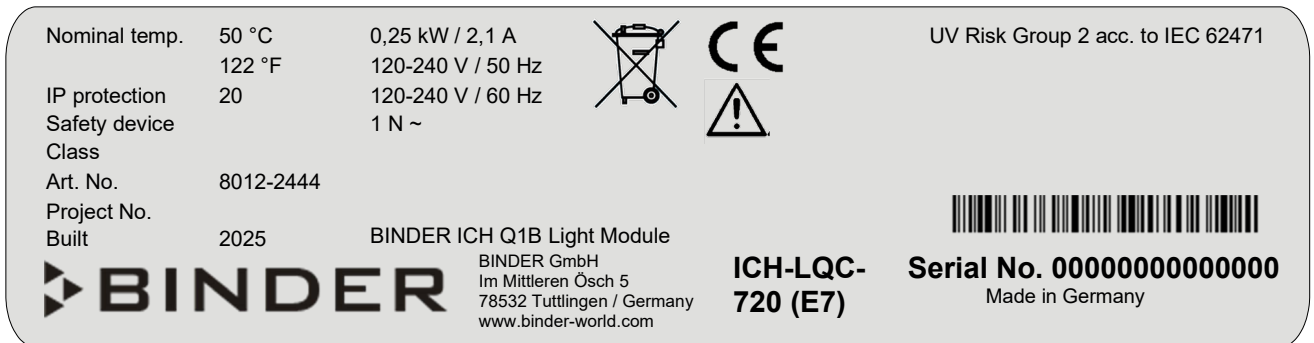





Figure 2: Type plate of ICH Q1B light module (example: für chamber size 720)

Indications of the type plate (example)

Indication		Information
BINDER		Manufacturer: BINDER GmbH
ICH-LQC-720 (E7)		Model
BINDER ICH Q1B Light Module		Model designation: BINDER ICH Q1B light module
Serial No.	00000000000000	Serial no. of the device
Built	2025	Year of construction
Nominal temperature	50 °C / 122 °F	Nominal temperature
IP protection	20	IP type of protection acc. to standard EN 60529
Temp. safety device	---	Temperature safety device acc. to standard DIN 12880:2007
Class	---	Class of temperature safety device
Art. No.	8012-2444	Art. no. of the device
Project No.	---	Optional: Special application acc. to project no.
0,25 kW		Nominal power
2,1 A		Nominal current
120-240 V, 50 Hz		Nominal voltage range +/-10% at the indicated power frequency
120-240 V, 60 Hz		
1 N ~		Current type
UV Risk Group 2 acc. to IEC 62471		UVA radiation of risk group 2 acc. to IEC 62471

Symbols on the type plate

Symbol	Information
	CE conformity marking
	Electrical and electronic equipment manufactured / placed on the market in the EU after 13 August 2005 and be disposed of in separate collection according to Directive 2012/19/EU on waste electrical and electronic equipment (WEEE).
	Observe the safety instructions in the operating manual

1.7 UKCA Label

The sticker with UKCA Authorised Representative details sticks next to the type plate on the front of the CO₂ control box.



Figure 3: UKCA Label

Symbol on the sticker

Symbol	Information
	UKCA conformity marking



1.8 General safety instructions on installing and operating the BINDER ICH Q1B light module accessory

With regard to operating the ICH Q1B light module and to the installation location, please observe the local and national regulations relevant for your country (for Germany: DGUV guidelines 213-850 on safe working in laboratories, issued by the employers' liability insurance association).

BINDER GmbH is only responsible for the safety features of the CO₂ control module provided skilled electricians or qualified personnel authorized by BINDER perform all maintenance and repair, and if components relating to chamber safety are replaced in the event of failure with original spare parts.



NOTICE	
	<p>Danger of overheating due to lack of ventilation. Damage to the device.</p> <ul style="list-style-type: none"> ⊘ Do NOT install the BINDER chamber with accessory in unventilated recesses. ➤ Ensure sufficient ventilation for dispersal of the heat. ➤ Observe the prescribed minimum distances when installing the BINDER chamber.

Do not install or operate the accessory in hazardous locations. The device does not dispose of any measures of explosion protection.

 DANGER	
	<p>Danger of explosion due to combustible dusts or explosive mixtures in the vicinity of the chamber. Serious injury or death from burns and / or explosion pressure.</p> <ul style="list-style-type: none"> ⊘ Do NOT operate the chamber in potentially explosive areas. ⊘ Make sure that there are NO combustible dust or air-solvent mixtures in the vicinity of the accessory. This includes the inner chamber of the cooling incubator/climate chamber.



The BINDER ICH Q1B light module was produced in accordance with VDE regulations and were routinely tested in accordance to VDE 0411-1 (IEC 61010-1).

During and shortly after operation, the temperature of the light cassette surfaces almost equals the set-point. The light cassettes will become hot during operation.

	 CAUTION
	<p>Danger of burning by touching hot chamber parts during or after operation. Burns.</p> <p>∅ Do NOT touch the light cassettes during operation.</p>

The lighting is classified into the following risk groups according to IEC 62471:

- VIS light source: Danger from blue light corresponding to risk group 1
- UVA light source: Danger from UV radiation corresponding to risk group 2

	 WARNING
	<p>Danger of eye and skin injury by UV light hazard. Eye and skin injury.</p> <p>∅ DO NOT look directly into the radiation.</p> <p>➤ Keep skin exposure to radiation as low as possible.</p> <p>➤ Wear UVA protective goggles when opening the door of the cooled incubator/climate chamber when the light is on</p>

1.9 Intended use

	<p>Following the instructions in this operating manual and conducting regular maintenance work (chap. 14) are part of the intended use.</p>
---	---

Any use of the accessory that does not comply with the requirements specified in this Operating Manual shall be considered improper use.

Other applications than those described in this chapter are not approved.



It is also not permitted to make any modifications to the accessory yourself, as this would be contrary to the intended use.

Use



The "BINDER ICH Q1B Light module" and "BINDER ICH Q1B Light module with Quantum Control LQC" accessories are provided for use with BINDER cooling incubators series KB PRO (E7) and BINDER constant climate chambers series KBF / KBF-UL and KBF PRO (E7). The light control works via the MB2 chamber controller.

The operating manuals for these chambers, in particular the safety instructions and the intended use, must be observed when using the accessory.

The accessory does not dispose of any measures of explosion protection.

 	 DANGER
	<p>Explosion or implosion hazard and danger of poisoning through the introduction of unsuitable loading material.</p> <p>Poisoning. Serious injury or death from burns and / or explosion pressure.</p> <p>∅ Do NOT introduce any substance combustible or explosive at working temperature into the chamber, in particular no energy sources such as batteries or lithium-ion batteries.</p> <p>∅ NO explosive dust or air-solvent mixture in the inner chamber.</p> <p>∅ Do NOT introduce any substance which could lead to release of toxic gases.</p>

Contamination of the accessory by toxic, infectious or radioactive substances must be prevented

	WARNING
 	<p>Danger of intoxication and infection through contamination of the chamber with toxic, infectious or radioactive substances.</p> <p>Damages to health.</p> <ul style="list-style-type: none"> ➤ Protect the accessory from contamination by toxic, infectious or radioactive substances. ➤ Take suitable protective measures when introducing and removing toxic, infectious or radioactive material

In case of foreseeable use of the chamber there is no risk for the user through the integration of the chamber into systems or by special environmental or operating conditions in the sense of EN 61010-1:2010. For this, the intended use of the chamber and all its connections must be observed.

Medical devices

The accessory is not classified as medical devices as defined by the Medical Device Directive 93/42/EEC and Regulation (EU) No 2017/745.

Personnel Requirements

Only trained personnel with knowledge of the Operating Manual can set up and install the accessory, start it up, operate, clean, and take it out of operation. Service and repairs call for further technical requirements (e.g. electrical know-how), as well as knowledge of the service manual.

Installation site requirements

BINDER chambers and accessories are designed for setting up inside a building (indoor use).

The requirements described in the Operating Manual for installation site and ambient conditions (chap. 3.5) must be met.

	<p>WARNING: If customer should use chambers and accessories running in non-supervised continuous operation, we strongly recommend in case of inclusion of irrecoverable specimen or samples to split such specimen or samples and store them in at least two chambers, if this is feasible.</p>
---	--

1.10 Foreseeable Misuse

Other applications of the accessory than those described in chap. 1.9 are not approved.

This expressly includes the following misuses (the list is not exhaustive), which pose risks despite the inherently safe construction and existing technical safety equipment:

- Non-observance of Operating Manual
- Non-observance of information and warnings on the cooling incubator/climate chamber (e.g. control unit messages, safety identifiers, warning signals)
- Installation, startup, operation, maintenance and repair of the cooling incubator/climate chamber and the accessory by untrained, insufficiently qualified, or unauthorized personnel
- Missed or delayed maintenance and testing
- Non-observance of traces of wear and tear
- Insertion of materials excluded or not permitted by this Operating Manual.
- Non-compliance with the admissible parameters for processing the respective material.
- Installation, testing, service or repair in the presence of solvents

- Installation of replacement parts and use of accessories and operating resources not specified and authorized by the manufacturer
- Installation, startup, operation, maintenance or repair of the accessory in absence of operating instructions
- Bypassing or changing protective systems, operation of the accessory without the designated protective systems
- Non-observance of messages regarding cleaning and disinfection of the accessory.
- Spilling water or cleaning agent on the accessory, water penetrating into the chamber during operation, cleaning or maintenance.
- Cleaning activity while the cooling incubator/climate chamber or accessory is turned on.
- Operation of the accessory with a damaged housing or damaged power cord
- Continued operation of the accessory during an obvious malfunction
- Insertion of objects, particularly metallic objects, in louvers or other openings or slots on the accessory
- Human error (e.g. insufficient experience, qualification, stress, exhaustion, laziness)

To prevent these and other risks from incorrect operation, the operator shall issue operating instructions. Standard operating procedures (SOPs) are recommended.

1.11 Residual Risks

The unavoidable design features of a chamber or accessory, as well as its proper field of application, can also pose risks, even during correct operation. These residual risks include hazards which, despite the inherently safe design, existing technical protective equipment, safety precautions and supplementary protective measures, cannot be ruled out.

Messages on the chamber and accessory and in the Operating Manual warn of residual risks. The consequences of these residual risks and the measures required to prevent them are listed in the Operating Manual. Moreover, the operator must take measures to minimize hazards from unavoidable residual risks. This includes, in particular, issuing operating instructions.

The following list summarizes the hazards against which this Operating Manual warn, and specifies protective measures at the appropriate spots:

Unpacking, Transport, Installation

- Sliding or tilting of the accessory
- Setup of the accessory in unauthorized areas
- Installation of a damaged accessory
- Installation of an accessory with damaged power cord / power supply unit
- Inappropriate site of installation
- Missing protective conductor connection

Normal operation

- Assembly errors
- Emission of non-ionizing radiation from electrical operating resources
- Contact with live parts in normal state
- Opening the door of the cooling incubator/climate chamber without UVA protective goggles when the light is on.

Cleaning and Decontamination

- Penetration of water into the CO₂ control box
- Inappropriate cleaning and decontamination agents

Malfunction and Damage

- Continued operation of the accessory during an obvious malfunction
- Contact with live parts during error status

Operation of the accessory with damaged power cord

Maintenance

- Maintenance work on live parts.
- Execution of maintenance work by untrained/insufficiently qualified personnel
- Electrical safety analysis during annual maintenance not performed

Trouble-shooting and Repairs

- Trouble-shooting of live parts without specified safety measures
- Absence of a plausibility check to rule out erroneous inscription of electrical components
- Performance of repair work by untrained/insufficiently qualified personnel
- Inappropriate repairs which do not meet the quality standard specified by BINDER
- Use of replacement parts other than BINDER original replacement parts
- Electrical safety analysis not performed after repairs

1.12 Operating instructions

Depending on the application and location of the chamber, the operator of the cooling incubator/climate chamber with accessory must provide the relevant information for safe operation of the chamber in a set of operating instructions.



Keep these operating instructions with the chamber at all times in a place where they are clearly visible. They must be comprehensible and written in the language of the employees.

1.13 Measures to prevent accidents

The operator of the cooling incubator/climate chamber with CO₂ control module accessory must observe the local and national regulations (for Germany: the rule "Operation of work equipment. Operation of refrigeration systems, heat pumps and refrigeration equipment", GUV-R 500 chap. 2.35) and take precautions to prevent accidents

The manufacturer took the following measures to prevent ignition and explosions:

- **Indications on the type plate**
See operating manual chap. 1.6.
- **Operating manual**
An operating manual is available for each chamber and accessory.
- **Safety, measurement, and control equipment**
The safety, measuring, and control equipment is easily accessible.
- **Electrostatic charge**
The interior parts are grounded.

- **Non-ionizing radiation**

Non-ionizing radiation is not intentionally produced, but released only for technical reasons by electrical equipment (e.g. electric motors, power cables, solenoids). The machine has no permanent magnets. If persons with active implants (e.g. pacemakers, defibrillators) keep a safe distance (distance of field source to implant) of 30 cm, an influence of these implants can be excluded with high probability.

- **Protection against touchable surfaces**

Tested according to EN ISO 13732-1:2008.

- **Cleaning**

See operating manual chap. 13.

2. Device description

2.1 Extension of the functionality of the KB PRO, KBF, and KBF PRO chambers with the ICH Q1B Light module accessory and with the ICH Q1B Light module with Quantum Control LQC

KB PRO cooling incubators and KBF und KBF PRO constant climate chambers with the ICH Q1B Light module accessory as well as devices with the additional Quantum Control function LQC are equipped with a multifunctional microprocessor display controller for temperature and humidity (KBF, KBF PRO) with a digital display accurate to one-tenth of a degree resp. 0.1 %. With its comprehensive program control functions, the display program controller MB2 permits the high precision performance of temperature and humidity (KBF, KBF PRO) cycles.

The devices meet the requirements of the prescribed stability and shelf life tests for pharmaceutical products: Photostability tests according to ICH guideline CPMP/ICH/279/95 (Q1B).

Quantum Control LQC: The Quantum Control function permits integration of UV intensity and luminous intensity inside the usable volume. The optical sensors used according to the ICH guideline for stability and durability tests of pharmaceutical products Q1B. Sensor measurement is to a great extent directionally independent, diffused light is also weighted. The function Light Quantum Control permits apart from displaying the actual values of UVA and the visible spectral range cumulative measurement of the light doses. In Manual Mode target dose values of UVA and the visible spectral range can be entered. When they are reached, the fluorescent tubes or LEDs are automatically turned off and notifying and alarm messages are released.

Controller: All parameters are controlled via the MB2 chamber controller. It is not possible to operate the accessory without connection to the cooling incubator/climate chamber.

The efficient program controller is equipped with a multitude of operating functions, in addition to recorder and alarm functions. Programming of test cycles is easily accomplished via the modern MB2 touch screen controller and is also possible directly with a computer via Intranet in connection with the APT-COM™ 4 Multi Management Software (accessory). The chamber comes equipped with an Ethernet serial interface for computer communication. In addition, the BINDER APT-COM™ 4 Multi Management Software permits networking up to 100 chambers and connecting them to a PC for controlling and programming, as well as recording and representing temperature and humidity data and illumination data.

Temperature range with illumination

10 °C / 50 °F up to 60 °C / 140 °F with an ambient temperature of 22 °C +/- 3°C / 71.6 °F +/- 5.4 °F.

KBF / KBF PRO: For the control ranges of temperature and humidity, see climatic diagrams (chap. 12).



When using the accessories ICH Q1B Light module or ICH Q1B Light module with Quantum Control, the CO₂ control module accessory cannot be used at the same time.

2.2 Description of the BINDER ICH Q1B Light module accessory and BINDER ICH Q1B Light module with Quantum Control LQC

The BINDER ICH Q1B Light module consists of the ICH Q1B light box with connections and two light cassettes with connection cables. One of the light cassettes is equipped with LED for cool white light (VIS), the other one with fluorescent tubes for UVA light (UVA). The accessory with Quantum Control LQC additionally provides two spherical light sensors for VIS and UVA measurement.

Principle of light control: CO₂ control is carried out via the MB2 chamber controller. Operation without connection to the cooling incubator/climate chamber is not possible



ICH Q1B light module with Quantum Control LQC: To activate the Quantum Control functionality, you must upload a new controller data set to the MB2 chamber controller. The required file can be downloaded from the BINDER Website <https://www.binder-world.com> via *Service - Download-Center - Products - controller data sets* and transferred to the chamber controller using a USB stick.

If the display and functionality of the MB2 chamber controller differs from that of the basic chamber without accessories, the corresponding menus are described in this manual.

Emission spectra of the light cassettes

The white light cassette (VIS) uses the latest LED technology with spectral characteristics similar to sunlight. The UVA range cannot be covered in accordance with ICH using current LED technology, which is why fluorescent tubes were used. The two light cassettes together reproduce the CIE-D65-like spectrum required by ICH very well.

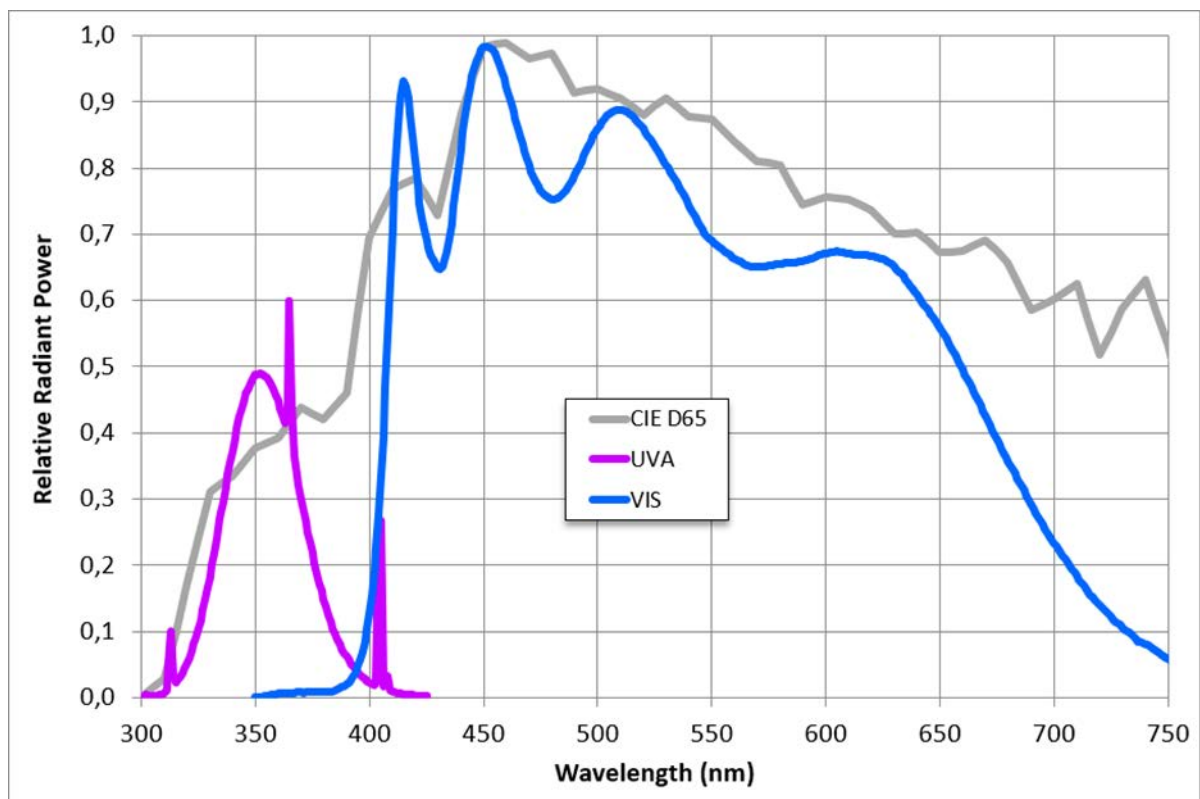

Figure 4: UVA and VIS (cold white) light spectra

- CIE D65 spectrum (daylight gray)
- VIS light cassette : white light spectrum LED SunLike cool white 6.500 K
- UVA light cassette: UVA spectrum Narva PUVA

Material of the ICH Q1B light box: The housing is RAL 9003 powder-coated. All corners and edges are also completely coated.

Material of the light cassettes: stainless steel V2A (German material no. 1.4301, US equivalent AISI 304).

The ICH Q1B light box is provided with a UVA warning sticker. A further warning sticker is included with the accessory. Attach it to the cooling incubator/climate chamber (chap. 4.1.3).

The accessory is powered by line voltage: 120-240 V wide voltage, 50/60 Hz

All necessary connection and fastening material as well as the power supply cable are included (scope of delivery chap. 3).

Classification: The lighting is classified into the following risk groups according to IEC 62471:

- VIS light source: Danger from blue light corresponding to risk group 1
- UVA light source: Danger from UV radiation corresponding to risk group 2

Connections and control elements on the ICH Q1B light box:

- Connection for IEC connector plug with country-specific plug
- "DATA IN" Ethernet socket (controller control from the cooling incubator/climate chamber)
- "DATA OUT" Ethernet socket (no function)
- On/Off switch
- Two connectors for the two light cassettes (VIS and UVA)
- With Quantum Control: connections for the two sensors VIS and UVA

2.3 Chamber overview: Cooling incubator/climate chamber with ICH Q1B light module

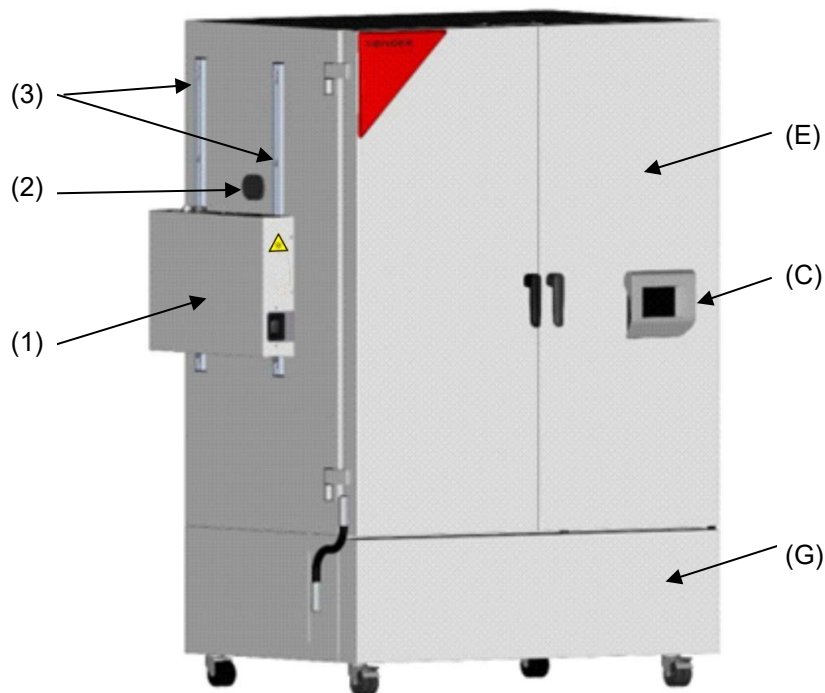

Figure 5: -Q1B light box, mounted on the cooling incubator/climate chamber (example KBF PRO 720)

- | | | | |
|-----|-----------------------|-----|--|
| (1) | ICH Q1B light box | (E) | Outer chamber door(s) |
| (2) | Elongated access port | (C) | Ergonomically adjustable control terminal (chamber sizes from 470) |
| (3) | Mounting rails | (G) | Refrigerating machine and humidity generation module |

2.4 Chamber overview: ICH Q1B light box

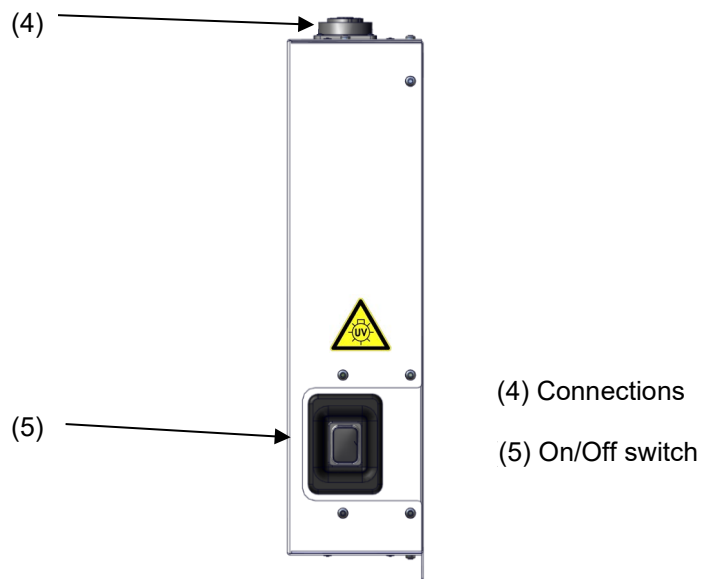

Figure 6: ICH Q1B light box, right front side

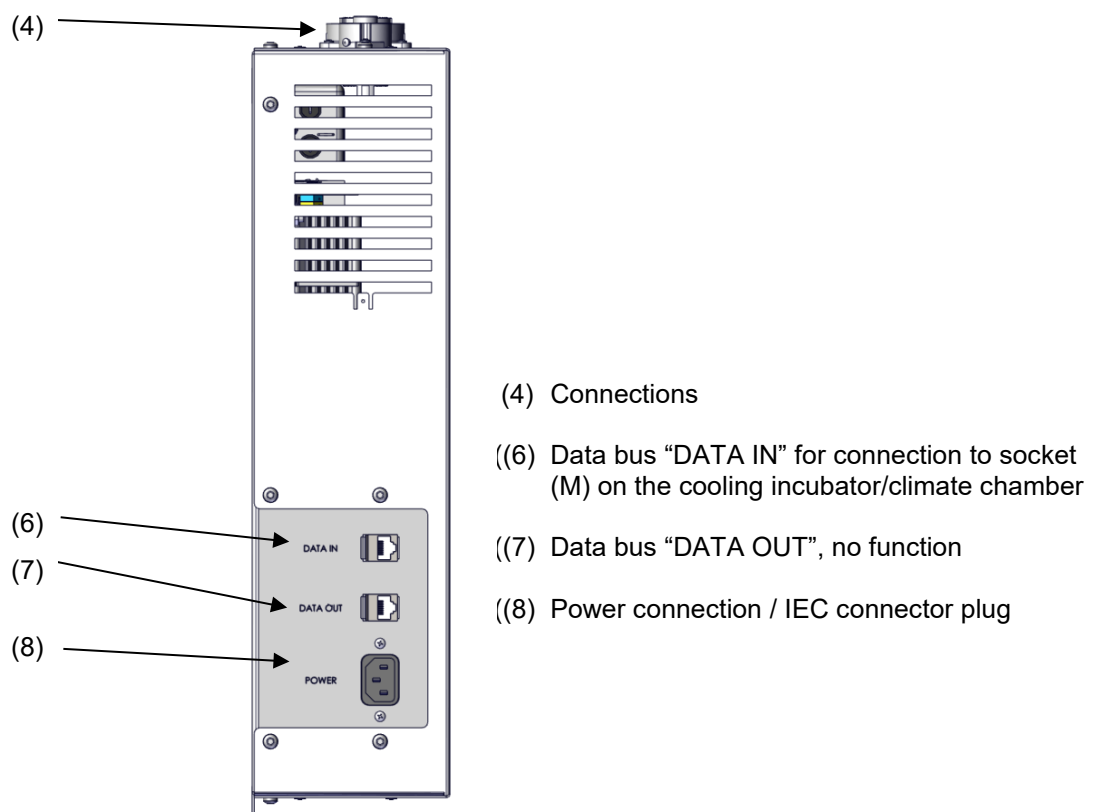

Figure 7: ICH Q1B light box, left side

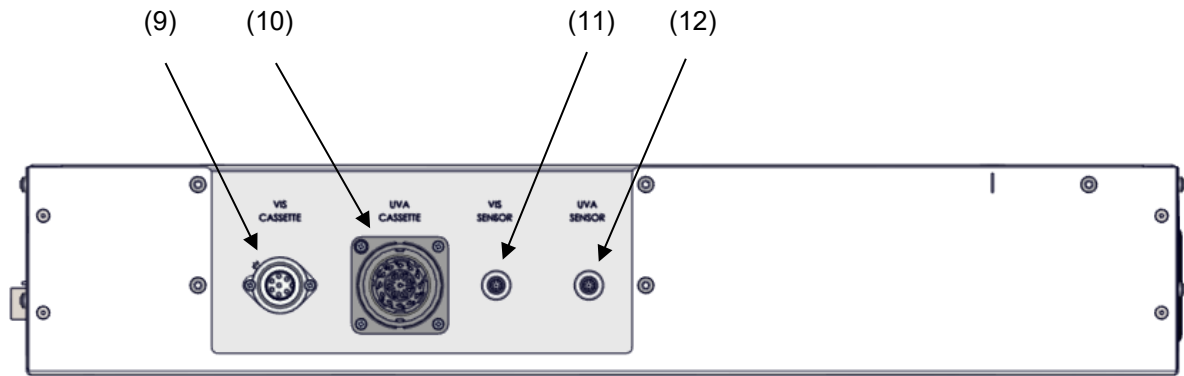

Figure 8: ICH Q1B Light box, view from top

- (9) Connection for VIS light cassette
- (10) Connection for UVA light cassette
- (11) Connection for VIS sensor
- (12) Connection for UVA sensor

2.5 Connection panel on the rear of the cooling incubator/climate chamber

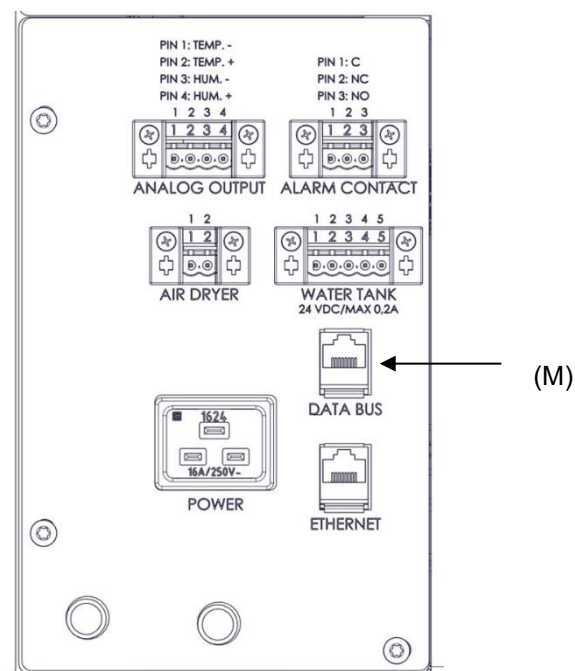

Figure 9: Control panel of the cooling incubator/climate chamber (example KBF PRO) with connections on the chamber rear, with optional equipment

- (M) Data Bus to connect to socket (6) of the ICH Q1B light box

3. Scope of delivery, transportation, storage, and installation

3.1 Scope of delivery of the ICH Q1B light module

- ICH Q1B light box
- UVA light cassette
- VIS light cassette
- UVA warning sticker
- Power supply cable
- Operating manual art. no. 7001-0577
- 2 mounting rails with screws (4 x M8, 2 x M5)
- 2 silicone foam plugs for elongated access port
- Patch cable for the data exchange between the ICH Q1B light box and the cooling incubator/climate chamber
- 2 U rails, right
- 2 U rails, left

3.2 Scope of delivery of the ICH Q1B light module with Quantum Control

- ICH Q1B Light box
- UVA light cassette
- VIS light cassette
- 2 spherical sensors with cables
- UVA warning sticker
- Power supply cable
- Operating manual art. no. 7001-0577
- 2 mounting rails with screws (4 x M8, 2 x M5)
- 2 silicone foam plugs for elongated access port
- Patch cable for the data exchange between the ICH Q1B light box and the cooling incubator/climate chamber
- 2 U rails, right
- 2 U rails, left

3.3 Unpacking, and checking equipment and completeness of delivery

Packen Sie das Zubehör vorsichtig aus, damit die sensiblen Lichtquellen (Leuchtstoffröhren und LED-Platinen) nicht beschädigt werden. After unpacking, please check the accessory based on the delivery receipt for completeness and for transportation damage. Inform the carrier immediately if transportation damage has occurred.

Please remove any transportation protection devices and adhesives in/on the accessory and remove the operating manuals and accessory material from the packaging.

If you need to return the accessory, please use the original packing and observe the guidelines for safe lifting and transportation (chap. 3.4).

For disposal of the transport packing, see chap. 15.1.

Note on second-hand devices (Ex-Demo-Units):

Second-hand devices are devices that were used for a short time for tests or exhibitions. They are thoroughly tested before resale. BINDER ensures that the device is technically sound and will work flawlessly.

Second-hand devices are marked with a sticker on the device. Please remove the sticker before commissioning the devices.

3.4 Guidelines for safe transportation and storage

If possible, use the original packaging for transport. You can order transport packing for mov shipping purposes from BINDER service.

Permissible ambient temperature range during transport and storage: -10 °C / 14 °F to to +60 °C / 140 °F.

Intermediate storage of the accessory is possible in a closed and dry room. Observe the guidelines for temporary decommissioning (chap. 15.2).



When after storage in a cold location you transfer the accessory to its warmer installation site, condensation may form. Before start-up, wait at least one hour until the accessory has attained ambient temperature and is completely dry.

3.5 Location of installation and ambient conditions

The accessory is designed for setting up inside a building (indoor use).

	NOTICE
	<p>Danger of overheating due to lack of ventilation. Damage to the device.</p> <ul style="list-style-type: none"> ⊘ Do NOT install the accessory in unventilated recesses. ➤ Ensure sufficient ventilation for dispersal of the heat. ➤ Observe the prescribed minimum distances when installing the accessory.

Do not install or operate the accessory in potentially explosive areas.

	 DANGER
	<p>Danger of explosion due to combustible dusts or explosive mixtures in the vicinity of the device. Serious injury or death from burns and / or explosion pressure.</p> <ul style="list-style-type: none"> ⊘ Do NOT operate the accessory in potentially explosive areas. ➤ KEEP explosive dust or air-solvent mixtures AWAY from the vicinity of the accessory.

Ambient conditions for the ICH Q1B light box

- Permissible ambient temperature range during operation: +18 °C / 64.4 °F to +32 °C / 89.6 °F.

	<p>The ambient temperature should not be substantially higher than the indicated ambient temperature of +22 °C +/- 3 °C / 71.6 °F ± 5.4 °F to which the specified technical data relate. Deviations from the indicated data are possible for other ambient conditions.</p>
---	--

- Permissible ambient humidity: 70 % r.h. max., non-condensing
- Installation height: max. 2000 m / 6562 ft. above sea level.

Ambient conditions for the ICH Q1B light cassettes and light sensors

- Permissible ambient temperature inside the cooling incubator/climate chamber with light cassettes and/or light sensors: 5 °C / 41 °F up to up to 60 °C / 140 °F.
- Permissible humidity inside the cooling incubator/climate chamber with light cassettes and/or light sensors: see climatic diagrams (max. 80% r.h.)

	NOTICE
	<p>Danger of damage to the light cassettes and light sensors by excessive inner chamber temperature.</p> <p>Destruction of the light cassettes and light sensors.</p> <p>∅ Do NOT set a set-point above 60 °C / 140 °F on the controller if the light cassettes and/or light sensors are located inside the chamber.</p>

Other requirements

To completely separate the device from the power supply, you must disconnect the power plug. Install the device in a way that the power plug is easily accessible and can be easily pulled in case of danger.

For the user there is no risk of temporary overvoltages in the sense of EN 61010-1:2010.

Avoid any conductive dust in the ambience according to the chamber layout complying with pollution degree 2 (IEC 61010-1).

4. Installation and connections

4.1 Installation of the ICH Q1B light box on the cooling incubator/climate chamber

4.1.1 Installation of the mounting rails

Note the orientation of the mounting rails.

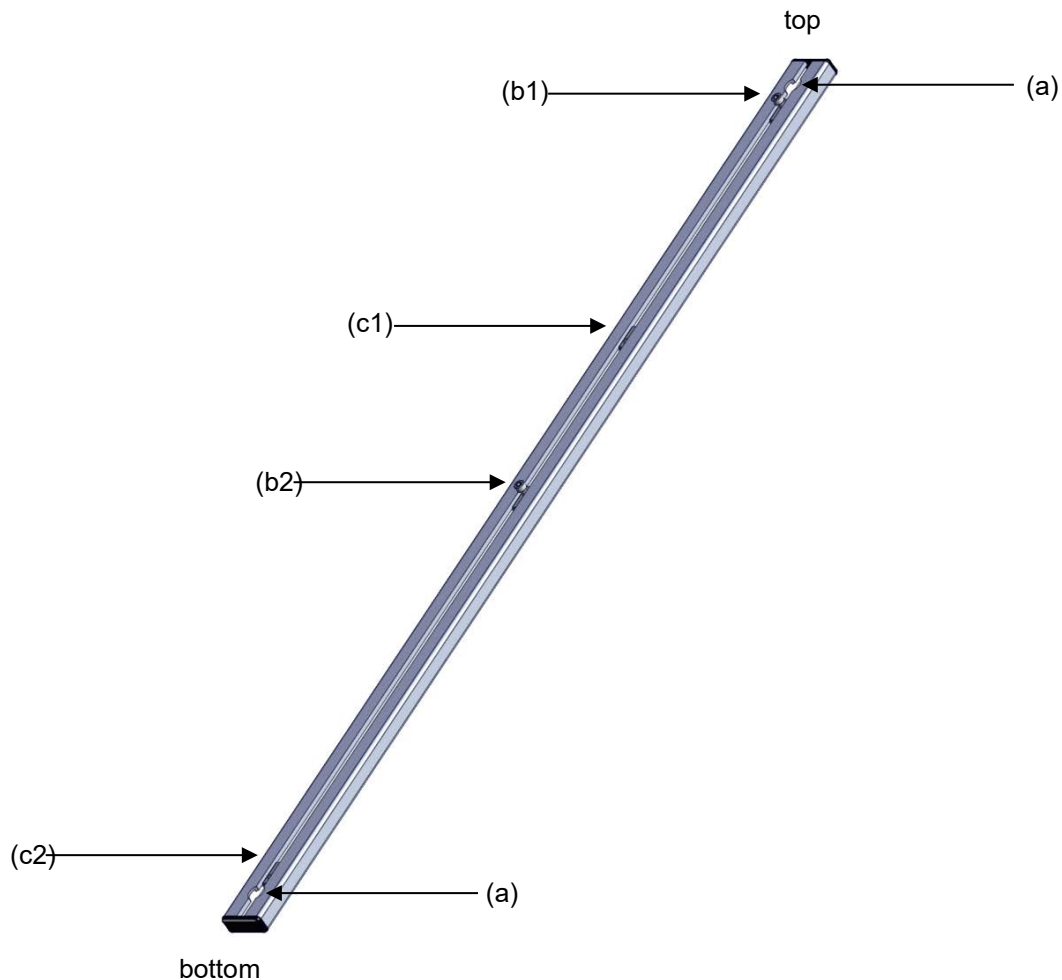
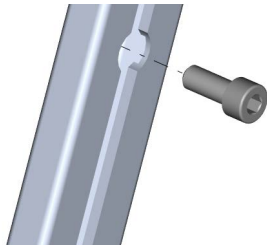

Figure 10: Mounting rail (delivery condition)

- (a) Holes for M8 screws for mounting the rails on the chamber side
- (b) Screws for hanging the accessory, pre-assembled
 - (b1) for CO₂ control box
 - (b2) for ICH-Q1B light box
- (c) Movable mounts for M5 screws for attaching the accessory
 - (c1) for CO₂ control box
 - (c2) for ICH-Q1B light box



Screw the two mounting rails onto the left side of the chamber. Use 2 of the 4 supplied M8 screws for each rail at position (a) of the rail.



Figure 11: Cooling incubator/climate chamber with installed mounting rails

4.1.2 Installing the ICH Q1B light box

- Hang the ICH Q1B Light box at the lower end of the mounting rails into the upper one of the pre-assembled screws (b2).
- The position of the lower mounts is determined by a small notch in the retaining rail, as the ball of the mount snaps into a notch here. Then screw the ICH Q1B Light box onto the two rails in position (c2) using the two M5 screws provided.



Figure 12: Screwing the ICH Q1B light box

4.1.3 Attaching the UVA warning sticker

The accessory comes with an additional UVA warning sticker. Attach it visibly on one of the doors of the cooling incubator/climate chamber.

4.2 Installing the light cassettes



For each of the light cassettes, hang two of the supplied U-rails into the side walls of the cooling incubator/climate chamber and then slide both light cassettes into position.

Recommended positions for the light cassettes:



In the following information, the side slots are counted from the top; the three numbers indicate the positions of the U-rail.

- KB PRO, KBF, KBF PRO size 260
VIS cassette: 3-4-5
UVA cassette: 16-17-18
- KB PRO, KBF, KBF PRO sizes 470 and 720:
VIS cassette: 3-4-5
UVA cassette: 28-29-30

Note: When inserting the cassettes, make sure that the LED boards and fluorescent tubes are not damaged. We recommend that two people insert the cassettes, especially the large and heavy cassettes for size 720 chambers.

	 CAUTION
	<p>Risk of injury from the sheet metal parts when inserting the light cassettes. Injuries. Damage to the light cassettes.</p> <ul style="list-style-type: none"> ➤ When inserting the light cassettes, be careful of sharp-edged metal parts. ➤ Handle the light cassettes carefully. ➤ If possible, install the light cassettes in chambers of size 720 with 2 people

The UVA light cassette must always be in the lower position. This serves to protect the eyes and to ensure uninterrupted operation of the ventilation system.

	 WARNING
	<p>Danger of eye and skin injury by UV light hazard. Eye and skin injury.</p> <ul style="list-style-type: none"> ⊘ DO NOT look directly into the radiation. ➤ Keep skin exposure to radiation as low as possible. ➤ Wear UVA protective goggles when opening the door of the cooled incubator/climate chamber when the light is on

Note: The lighting is classified into the following risk groups according to IEC 62471:

- VIS light source: Danger from blue light corresponding to risk group 1
- UVA light source: Danger from UV radiation corresponding to risk group 2

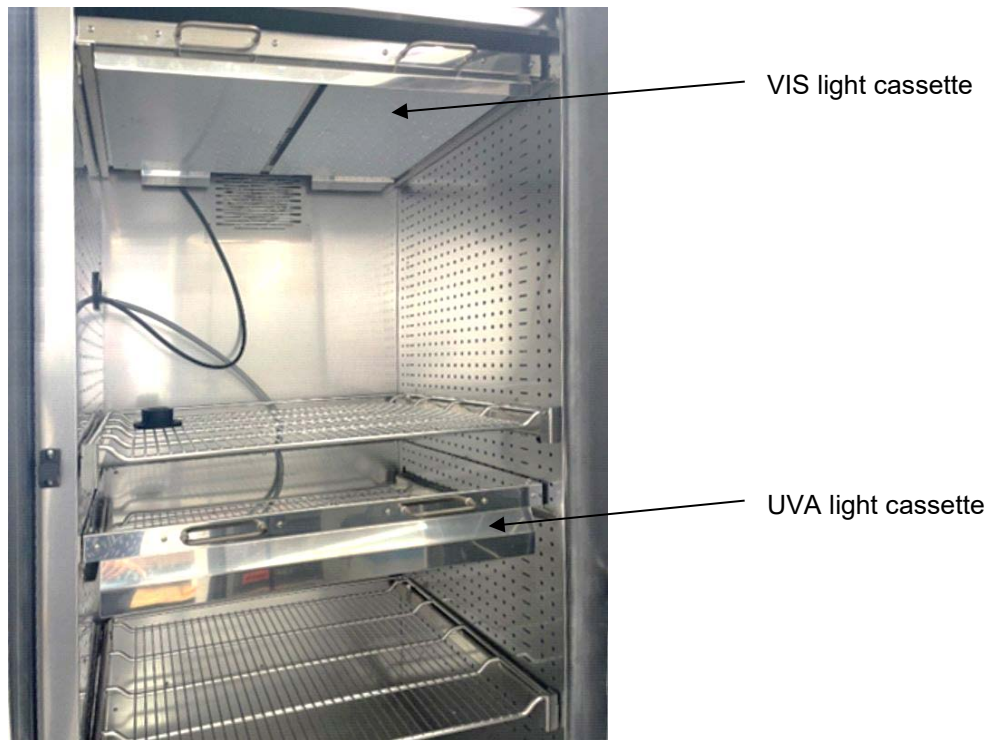

Figure 13: Positioning of the light cassettes

The plugs are then led out through the elongated access port.

4.3 Connecting the light cassettes to the ICH Q1B light box

- Remove the protective covers over the two sockets “VIS CASSETTE” and “UVA CASSETTE” by unscrewing.
- Insert the plug of the UVA cassette into the socket marked “UVA CASSETTE” on the top of the ICH Q1B light box and then turn it until it clicks into place
- Insert the plug of the VIS cassette into the socket marked “VIS CASSETTE” on the top of the ICH Q1B light box. This plug is threaded and should be tightened by hand.

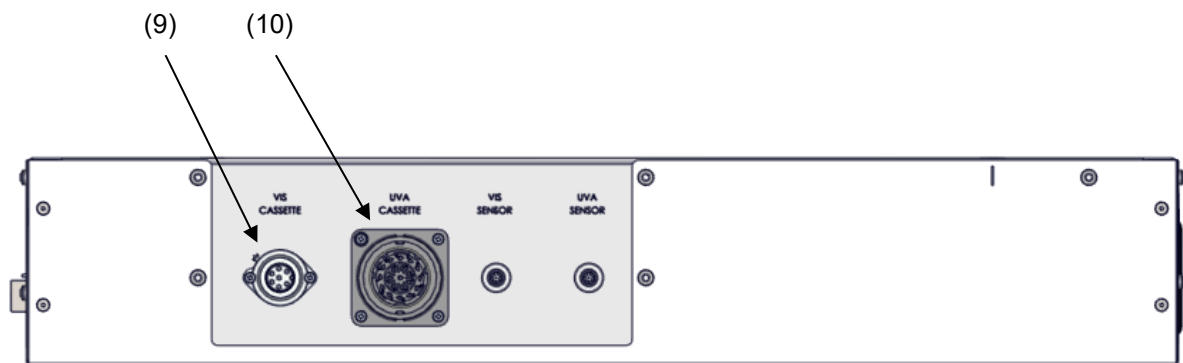



Figure 14: Sockets to connect the light cassettes on the ICH Q1B light box

- (9) Connection for VIS light cassette
- (10) Connection for UVA light cassette



Figure 15: Connections of the light cassettes on the top of the ICH Q1B light box, mounted

	NOTICE
	<p>Danger of damage to the fluorescent tubes and LEDs. Damage to the chamber.</p> <ul style="list-style-type: none"> Ø DO NOT plug or unplug the plugs of the two light cassettes during operation. ➤ Turn off the lighting system using the On/Off switch (5) before plugging or unplugging the plugs of the light cassettes.

Maximum ambient temperature of the light cassettes: 60 °C / 140 °F. At higher temperatures, the light cassettes will be destroyed.

As soon as the ICH Q1B light box is switched on and/or at least one of the controller functions "Light UVA" or "Light VIS" is activated, the maximum temperature of the chamber is automatically limited to 60 °C / 140 °F.

	NOTICE
	<p>Danger of damage to the light sensors by excessive inner chamber temperature. Destruction of the light sensors.</p> <ul style="list-style-type: none"> Ø Do NOT plug in the light sensors when the interior temperature is above 60 °C / 140 °F and do NOT leave them in the interior. Ø Do NOT set a set-point above 60 °C / 140 °F on the controller if the light sensors are located inside the chamber.

4.4 Connecting the light sensors to the ICH Q1B light box (ICH Q1B light module with Quantum Control)

Two light sensors are placed inside the chamber to measure the illuminance and UV intensity. They can be positioned anywhere. They are each provided with a 2 m long cable. Insert the plugs of the two sensors into the sockets marked "VIS SENSOR" and "UVA SENSOR" on the top of the ICH Q1B light box.

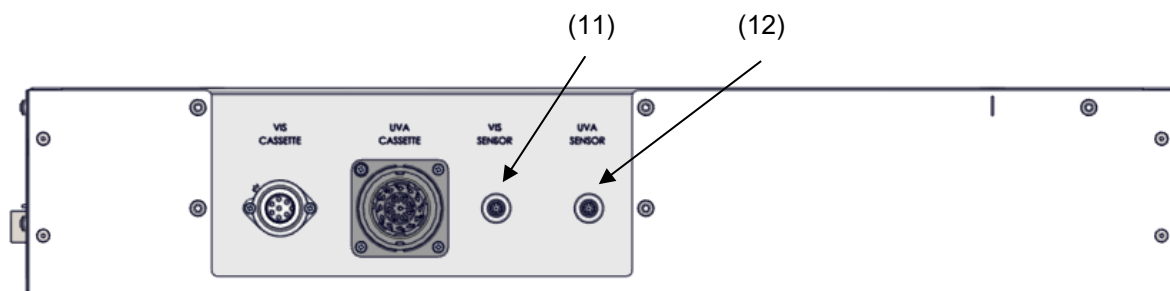



Figure 16: Sockets to connect the light sensors on the ICH Q1B light box

(11) Connection for VIS sensor

(12) Connection for UVA sensor

Maximum ambient temperature of the light cassettes: 60 °C / 140 °F. At higher temperatures, the light cassettes will be destroyed.

As soon as the ICH Q1B light box is switched on and/or at least one of the light sensors is plugged in, the maximum temperature of the chamber is automatically limited to 60 °C / 140 °F. When exceeding the actual or set-point value of 60 °C / 140 °F due to an excessively high temperature set-point or in the event of an error, the alarm message "Light sensor 60 °C!" is displayed (chap. 11.1.2). As soon as the chamber has cooled down to a value below 60 °C / 140 °F or the set-point has been set accordingly, the message disappears.

	NOTICE
	<p>Danger of damage to the light sensors by excessive inner chamber temperature. Destruction of the light sensors.</p> <ul style="list-style-type: none"> ∅ Do NOT plug in the light sensors when the interior temperature is above 60 °C / 140 °F and do NOT leave them in the interior. ∅ Do NOT set a set-point above 60 °C / 140 °F on the controller if the light sensors are located inside the chamber.

For the characteristic features of the light sensors see chap. 12.2.

4.5 Inserting the silicone foam plugs

- Guide the cables of the light cassettes into the corresponding slots through the two silicone foam plugs provided. Round recesses are provided in the plugs for the two thicker cables of the light cassettes.
- *ICH Q1B light module with Quantum Control:* Guide the cables of the sensors in the corresponding slots through the two silicone foam plugs.
- Insert both silicone foam plugs into the elongated access port (one from the inside and one from the outside)



4.6 Establishing the data connection between the ICH Q1B light box and the cooling incubator/climate chamber

Use the supplied patch cable for the data connection from the ICH Q1B light box to the cooling incubator/climate chamber. Connect the connection (6) "DATA IN" on the ICH Q1B light box to the socket (M) "DATA BUS" on the cooling incubator/climate chamber.

4.7 Electrical connection

The connection socket for the IEC connector plug is located on the rear of the ICH Q1B light box.

- Nominal voltage +/-10%: 120-240 V at 50 and 60 Hz
- Power plug: Grounded plug with country-specific plug
- Current type: 1N~
- Device fuse: 16 A
- The domestic socket must also provide a protective conductor. Make sure that the connection of the protective conductor of the domestic installations to the chamber's protective conductor meets the latest technology. The protective conductors of the socket and plug must be compatible!

	 DANGER
	<p>Electrical hazard due to missing protective conductor connection. Deadly electric shock.</p> <ul style="list-style-type: none"> ➤ Make sure that the chamber's power plug and the power socket match and securely connect the electrical protective conductors of the chamber and the house installation.

- Only use original connection cables from BINDER according to the above specification.
 UL chambers: Use only a UL Listed Power supply cord (UL category ELBZ), SJT 3x14 AWG (2.08 mm²); C13L. For outside USA use a certified power supply cord according to national requirements.
- Prior to connection and start-up, check the power supply voltage. Compare the values to the specified data located on the chamber's type plate (left chamber side, bottom right-hand, see chap. 1.6).



	NOTICE
	<p>Danger of incorrect power supply voltage due to improper connection. Damage to the chamber.</p> <ul style="list-style-type: none"> ➤ Check the power supply voltage before connection and start-up. ➤ Compare the power supply voltage with the data indicated on the type plate.

- When connecting, please observe the regulations specified by the local electricity supply company as well as the local or national electrical regulations (VDE directives for Germany).
- Observe a sufficient current protection according to the number of devices that you want to operate. We recommend the use of a residual current circuit breaker.
- Pollution degree (acc. to IEC 61010-1): 2
- Installation category (acc. to IEC 61010-1): II

See also electrical data (chap. 16).

	<p>To completely separate the chamber from the power supply, you must disconnect the power plug. Install the device in a way that the power plug is easily accessible and can be easily pulled in case of danger.</p>
---	---

When connected to a power supply 1N~ with a frequency of 60 Hz, a leakage current of more than 3.5 mA is possible. If grounding through the power cable is insufficient or missing, the leakage current may flow through the user's body. Correct installation of the professional grade power socket provided by the user safely avoids this. Before connecting the chamber to the socket, please check its grounding contact type plug for appropriate construction and if it is undamaged.

	 DANGER
	<p>Electrical hazard by high leakage current. Deadly electric shock.</p> <ul style="list-style-type: none"> ➤ Earth connection is essential before connecting supply. Check socket before inserting plug.

5. Functional overview of the MB2 chamber controller

The MB2 chamber controller controls following parameters inside the chamber:

- Temperature in °C
- Relative humidity in % r.h.
- Fan speed in %
- Illumination

ICH Q1B light module with Quantum Control: In addition to displaying the actual values of UVA and the visible spectral range, the function "Light Quantum Control" permits cumulative measurement of the light doses. In Manual Mode you can enter target dose values of UVA and the visible spectral range. When they are reached, the UVA fluorescent tubes and cool white LEDs automatically turn off independently from each other

For the control ranges of temperature and humidity, see climatic diagrams (chap. 12).

You can enter the desired set point values in fixed value operation mode directly on the display surface or via the setpoint menu. For program operation the controller offers programming week and time programs. In addition, there is a timer program available (stopwatch function).

The controller offers various notifications and alarm messages with visual and audible indication and remote alarms via e-mail, an event list (trace file) and the graphical display of the measuring values in the chart recorder view. The MB2 program controller permits programming temperature and humidity cycles, and specifying illumination, fan speed and special controller functions for each program section. You can enter values or programs directly at the controller or use the APT-COM™ 4 Multi Management Software (accessory) specially developed by BINDER.

ICH Q1B Light module:

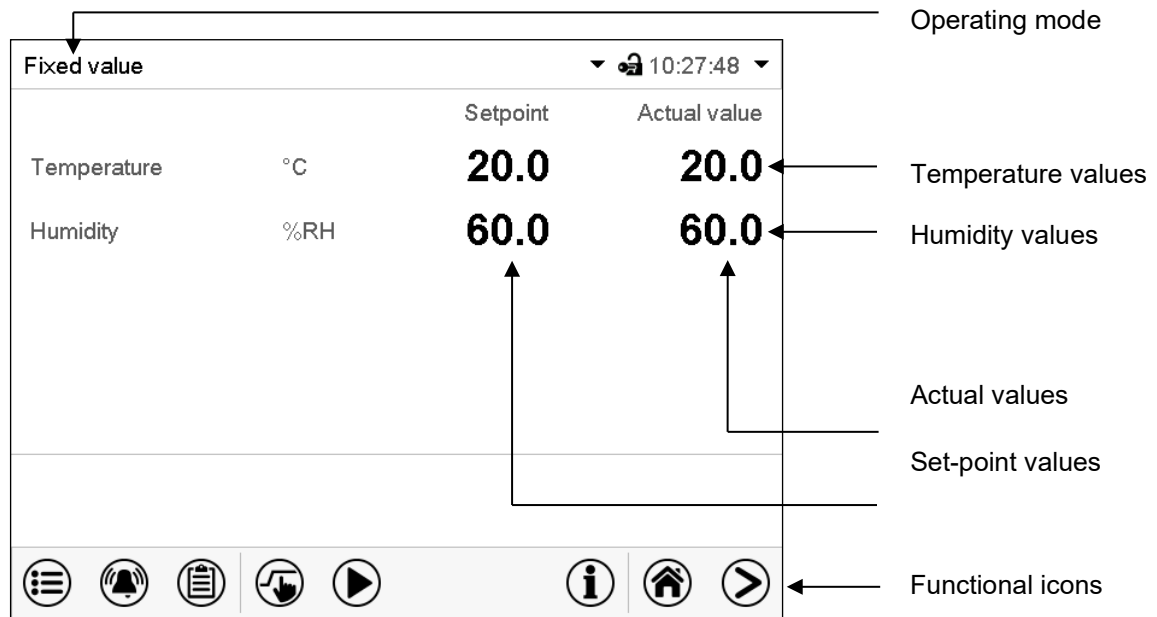

Figure 17: Normal display of the MB2 program controller (sample values)

ICH Q1B light module with Quantum Control:

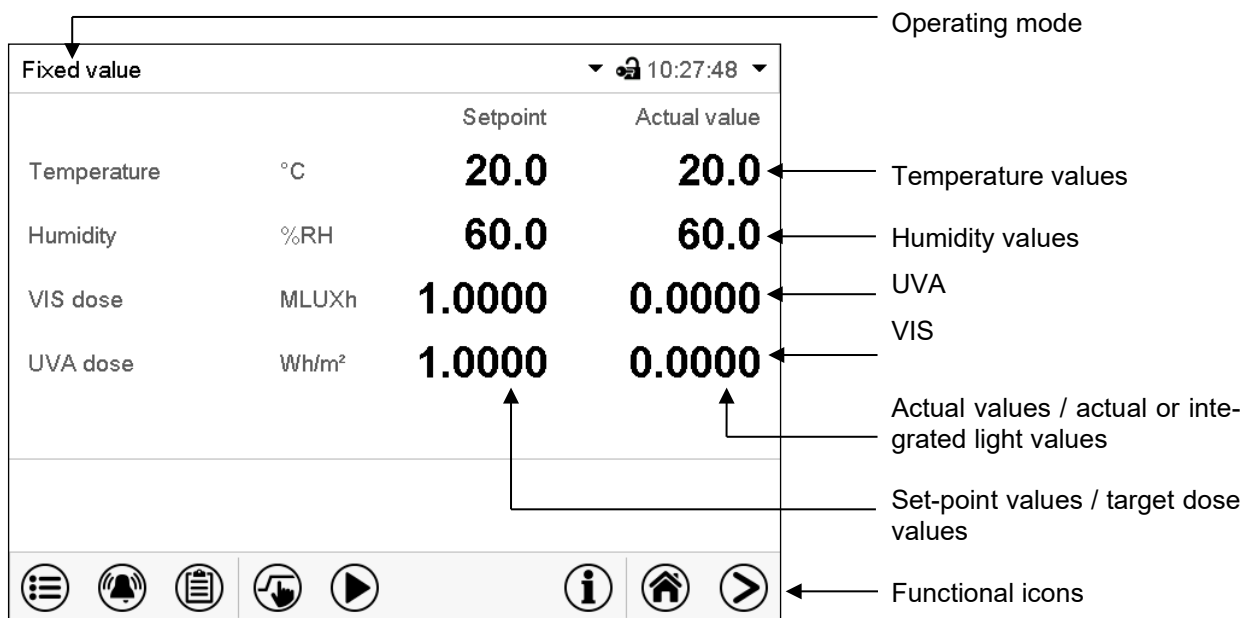



















Figure 18: Normal display of the MB2 program controller (sample values)

5.1 Controller icons overview











Navigation icons in Normal display

Icon	Signification	Function
	Main menu	Access from Normal display to the main menu
	Alarm	Access from Normal display to the list of active alarms
	Event list	Access from Normal display to the event list
	Setpoint setting	Access from Normal display to the setpoint entry menu: setpoint entry for Fixed value operation, turning on/off humidity control, safety controller settings
	Program start	Start a previously entered time or week program, continue a paused time program
	Program pause	Pause a running time program
	Program cancelling	Cancel a running time or week program
	Information	Information on program operation, setpoints, actual values, and the safety controller
	Normal display	Return from program display or chart recorder display to Normal display
	Change view	Toggle between Normal display, program display, and chart recorder display





Functional icons in individual menus

Icon	Signification	Function
	Back	Return from each menu to Normal display
	Update	Update the event list and alarm messages
	Confirm	Take over the entries and exit the menu / continue menu sequence.
	Close	Exit the menu / cancel menu sequence. Entries are not taken over. When terminating a menu sequence, an information window appears, which must be confirmed.
	Reset alarm	Acknowledge the alarm and mute the buzzer.
	Change keyboard	Change between uppercase and lower-case characters, digits and special characters
	Edit	Edit settings of time and week programs

Functional icons in the chart recorder display

Icon	Signification	Function
	Show legend	Show legend
	Hide legend	Hide legend
	Switch legend	Switch between legend pages
	Show indications	Show the indications "Door open" (B2)
	Hide indications	Hide the indications "Door open" (B2)
	History display	Pause chart recorder and change to history display. Data recording continues.
	Curve selection	Go to "Curve selection" submenu in the history display
	Search	Go to "Search" submenu in the history display to select the required instant
	Zoom	Go to "Zoom" submenu in the history display to select the zoom factor
	Show scroll buttons	Show scroll buttons in the history display to scroll to an instant
	Hide scroll buttons	Hide scroll buttons in the history display to scroll to an instant

Information icons referring to chamber conditions

Icon	Text information	Condition
	"Idle mode"	Controller in Idle mode
	"Temperature range"	Current actual temperature value outside the tolerance range
	"Humidity range"	Current actual humidity value outside the tolerance range
	"Door open"	Chamber door is open
	"Humidity off"	The humidification / dehumidification system is turned off
VIS	"Light VIS"	VIS light turned on (controller function "Light VIS" activated)
UVA	"Light UVA"	UVA light turned on (controller function "Light UVA" activated)
LQC	"LQC On"	ICH Q1B light module with Quantum Control: Light integration activated (controller function "LQC On" activated)

Information icon for data processing

Icon	Information
	Waiting icon: Data processing is running. Remaining time to touch the display when calibrating the touchscreen.

6. Start up

6.1 Turning on the cooling incubator/climate chamber

- After connecting the supply lines (chap. 4), turn on the cooling incubator/climate chamber by the On/Off switch (H). The ready-to-use indicator (signal triangle) is lit in green.

When the On/Off switch (H) is turned on and yet the controller display is dark, the display is in stand-by mode. Press on the touchscreen to activate it.

- Turn on the accessory at the On/Off switch.



When switched on for the first time, the new UVA fluorescent tubes must be burned in for 20 hours.

Warming chambers may release odors in the first few days after commissioning. This is not a quality defect. To reduce odors quickly we recommend running the disinfection program once or twice and in a well-ventilated location.



WARNING: If customer should use a BINDER chamber running in non-supervised continuous operation, we strongly recommend in case of inclusion of irrecoverable specimen or samples to split such specimen or samples and store them in at least two chambers, if this is feasible.



WARNING

Danger of eye and skin injury by UV light hazard.

Eye and skin injury.

- ⊘ DO NOT look directly into the radiation.
- Keep skin exposure to radiation as low as possible.
- Wear UVA protective goggles when opening the door of the cooled incubator/climate chamber when the light is on

6.2 Controller settings upon start up

The window “Language selection” enables the **language selection**, in case that it’s activated in the “Start-up” menu. Afterwards occurs a request of the **time zone** and the **temperature unit**.

Language selection
German
English
French
Spanish
Italian
✓

Start-up	
Temperature unit	Degrees Celsius
Time zone	UTC+1h (CET)
Daylight saving time switch	Automatic
▼ Start of daylight saving time	
▼ End of daylight saving time	
Language query after restart	Yes
✗	✓

The controller will function in the **operating mode**, which was active before the last shut-down. It controls temperature and humidity in fixed value operating mode to the last entered values and in the program mode to the set points achieved beforehand.

7. Function of light measurement and integration: ICH Q1B light module with Quantum Control

The chamber is equipped with fluorescent tubes for UVA and LED for the visible spectral range. These fluorescent tubes can be turned on with the controller functions “Light VIS” and “Light UVA”.

When controller function “LQC On” is activated, the fluorescent tubes and LEDs can also be turned on in fixed value or program operation mode by entering a dose target value, which is higher than a dose value already reached. As long as the controller functions “Light VIS” and “Light UVA” are not activated, the fluorescent tubes and LEDs automatically turn off when the respective dose target value is reached. Controller functions “Light VIS” and “Light UVA” permit turning on the fluorescent tubes and LEDs independent from automatic turn-off (or to prevent automatically turning-off) and thus to attain dose target values which are higher than the entered maximum dose. This permits turning on and off the UVA and the VIS tubes independently.

The intensities of illumination [LUX] and the UVA irradiance [W/m²] are measured by optical sensors in the inner chamber (instantaneous value display) and are integrated temporally (dose value display), i.e. the doses of illumination [MLUXh] and UVA [Wh/m²] increase every minute by the respective actual value. In the chart recorder display the instantaneous values are shown under “Instantaneous values” and the integrated light values under “Dose values”. The instantaneous value display serves to help the user find a representative measuring spot after charging and to control the correct function of the illumination equipment.

In fixed value or program operation mode, you can numerically enter target dose values for UVA and visible light.

- When the **VIS target dose is reached** the corresponding line in Normal Display is highlighted in green, and the message **VIS dose reached** is displayed in the event list.
- When the **UVA target dose is reached** the corresponding line in Normal Display is highlighted in green, and the message **UVA dose reached** is displayed in the event list.
- As soon as the second target dose is reached as well, in addition the **alarm message VIS and UVA doses reached** is displayed, and a buzzer sounds. The alarm can be acknowledged on the controller. The alarm message is displayed in the event list.
- If the controller functions “Light VIS” and “Light UVA” are not activated, the according **light sources turn off** to avoid exceeding the selected dose. If the controller functions “Light VIS” and “Light UVA” are activated, exposure to illumination and integration continue even after the message until the controller functions will be deactivated.



The measurement with Quantum Control is subject to an uncertainty of 10%. To comply with ICH requirements, it is recommended to increase the irradiation dose by 10%.

7.1 Display of the instantaneous and the integrated values

The instantaneous values and the dose values of VIS and UVA are constantly measured. The dose values (set-point and actual values) are always shown in Normal Display independent on the controller operation mode. Additionally, in the chart recorder display the instantaneous values (actual values) are shown under “Instantaneous values” and the integrated light values (set-point and actual values) under “Dose values”.

7.2 Measurement of illumination intensity and temporal integration

Controller function “LQC On” serves to start and stop the integrative function and to reset the integrated values of UVA and VIS. Controller functions “LQC reset VIS” and “LQC reset UVA” serve to reset to zero the integrated values once in a time.

- **Integrative function: controller function “LQC On” not activated**

The LQC symbol in the screen header indicates that the integrative function has been activated via controller function “LQC On”.

Integration takes place as soon as controller function “LQC On” is activated, and at least one target dose value other than 0.0 has been entered. With target dose value 0.0, or in case the entered target dose value has been reached, the fluorescent tubes and LEDs do not turn on automatically. The illumination can be turned on and off with the controller functions “Light VIS” and “Light UVA”.

Every minute the integrated values of UVA and VIS increase by the respective instantaneous value. The displayed units are Wh/m² and MLUXh. The maximum value of the integrated value display is the respective value reached with the last addition before exceeding 99999. The integration display on the controller display will then not increase any longer. Recording by the APT-COM™ 4 Multi Management Software (accessory) can continue correctly until overflow of the numeral format Floating Point.

In fixed value and program operation mode the illumination equipment automatically turns on when entering a dose target value higher than a dose value already reached. Additionally, activating controller functions “Light VIS” and “Light UVA” can prevent the automatic turning-off when the target dose value has been reached.

If controller function “Idle mode” is activated, the integrative function is not active. The illumination is off.

Integration continues until controller function “LQC On” is deactivated. The integrated values reached so far continually remain stored but are not displayed. Integration can be continued any time.

- **Resetting the integrated values**

Controller functions “LQC Reset VIS” and “LQC Reset UVA” serve to reset to zero **the integrated values** of UVA and VIS once in a time. To do this, the corresponding controller function must be activated for at least 5 seconds (consider when programming!). The reset is effective once, i.e. for a repeated reset, first deactivate the controller function (clear the checkbox and confirm) and then activate it again.

- **Controller function “LQC On” not activated**

There is no integration. Previously reached integrated values, if any, remain stored but are not displayed.

You can turn on the fluorescent tubes with the controller functions “Light VIS” and “Light UVA”.

The symbols “VIS” and “UVA” in the screen header indicate that the corresponding fluorescent tubes have been activated with the controller functions “Light VIS” and “Light UVA”.

8. Set-point entry in “Fixed value” operating mode

In Fixed value operating mode, you can enter a temperature set-point, a humidity set-point, the fan speed, and the switching-state of special controller functions.

All settings made in Fixed value operating mode remain valid until the next manual change. They are saved also when turning off the chamber or in case of toggling to Idle Mode or Program Mode.

	Setting ranges	Control ranges
Temperature KB PRO	-20 °C / -4 °F up to 100 °C / 212 °F	-20 °C / -4 °F up to 100 °C / 212 °F
Temperature KBF / KBF-UL	-5 °C / 41 °F up to 70 °C / 158 °F.	0 °C / 32 °F up to 70 °C / 158 °F without humidity 10 °C / 50 °F up to 70 °C / 158 °F with humidity
Temperature KBF PRO	-20 °C / -4 °F up to 100 °C / 212 °F	-20 °C / -4 °F up to 100 °C / 212 °F without humidity 10 °C / 50 °F up to 90 °C / 194 °F with humidity
Humidity KBF / KBF-UL	0 % r.h. up to 80 % r.h.	10 % r.h. to 80 % r.h. see climatic diagrams, chap. 12
Humidity KBF PRO	0 % r.h. up to 100 % r.h.	0 % r.h. to 98 % r.h. see climatic diagrams, chap. 12
UVA	0.0 Wh/m ² up to 99999 Wh/m ²	With Quantum Control: The actual dose values of VIS and UVA are constantly measured and shown in Normal Display together with the dose target values. When controller function “LQC On” is activated and the target dose value is higher than the actual dose value been entered, integration takes place. When reaching the target dose values the fluorescent tubes and LEDs automatically turn off, if they had not been additionally activated with the controller functions “Light VIS” and “Light UVA”. Also corresponding messages are displayed. For operating and principle of measurement, see chap. 7.
VIS	0.0 MLUXh up to 99999 MLUXh	
Fan speed	40% up to 100 %	

For the control range of temperature and relative humidity, see the temperature / humidity diagrams (chap. 12).

The temperature set-point is automatically limited to 60 °C in the following cases (individually or in combination):

- ICH Q1B light box turned on at the On/Off switch (5)
- Controller function “Light UVA” activated
- Controller function “Light VIS” activated
- Controller function “LCQ ON” activated

	NOTICE
	<p>Danger of damage to the light cassettes and light sensors by excessive inner chamber temperature.</p> <p>Destruction of the light cassettes and light sensors.</p> <p>⊘ Do NOT set a set-point above 60 °C / 140 °F on the controller if the light cassettes and/or light sensors are located inside the chamber.</p> <p>➤ We recommend setting the safety controller to Limit 60 °C / 140 °F to protect the light cassettes and light sensors.</p>

8.1 Set-point entry through the “Setpoints” menu

 Press the **Setpoint setting** icon to access the “Setpoint” setting menu from Normal display.

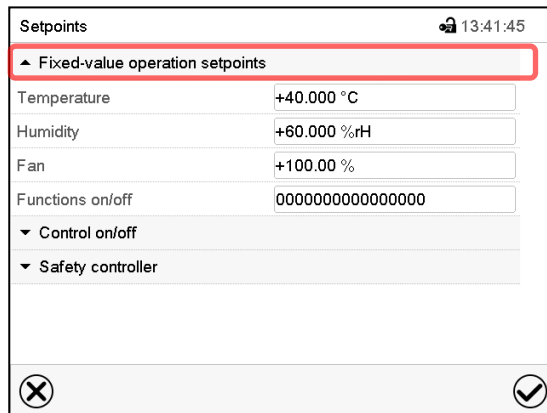

“Setpoints” menu without Quantum Control
(example KBF/KBF PRO)

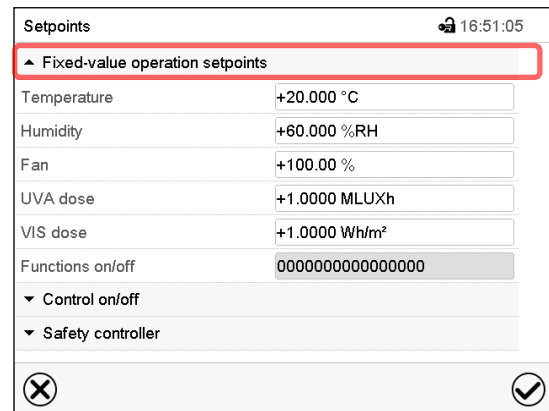

“Setpoints” menu with Quantum Control
(example KBF/KBF PRO)

- Select the field “Temperature” and enter the desired temperature setpoint.
KBF / KBF-UL setting range: -5 °C up to 70 °C, KB PRO / KBF PRO setting range: -20 °C up to 100 °C.
Confirm entry with **Confirm** icon.
- Select the field “Humidity” and enter the desired humidity setpoint.
KBF / KBF-UL setting range: 0% r.h. up to 80% r.h., KBF PRO setting range: 0% r.h. up to 100% r.h.
Confirm entry with **Confirm** icon.
- Select the field “Fan” and enter the desired fan speed setpoint.
Setting range: 40% up to 100% fan speed.
Confirm entry with **Confirm** icon.

With Quantum Control only:

- Select the field “UVA Dose” and enter the desired target dose.
Setting range: 0.0 Wh/m² up to 99999 Wh/m².
Confirm entry with **Confirm** icon.
- Select the field “VIS Dose” and enter the desired target dose.
Setting range: 0.0 MLUXh up to 99999 MLUXh.
Confirm entry with **Confirm** icon.

 When entering a value outside the setting range, the message: “Value outside of limits! (Min: xxx, Max: xxx)” appears (xxx is a wildcard for the limits of the respective parameter). Press the **Confirm** icon and repeat the entry with a correct value.

After completing the settings, press the **Confirm** icon to take over the entries and exit the menu, **or** press the **Close** icon to exit the menu without taking over the entries.

8.2 Direct setpoint entry via Normal display

Alternatively you can also enter the setpoints directly via Normal display.

Fixed value		Setpoint	Actual value
Temperature	°C	40.0	40.0
Humidity	%rH	60.0	60.0

Normal display without Quantum Control
(example KBF/KBF PRO)

Fixed value		Setpoint	Actual value
Temperature	°C	20.0	20.0
Humidity	%RH	60.0	60.0
VIS dose	MLUXh	1.0000	0.0000
UVA dose	Wh/m ²	1.0000	0.0000

Normal display with Quantum Control
(example KBF/KBF PRO)

8.3 Automatic correction of the actual value when turning on or off the illumination

The chambers have been adjusted for operation with maximum illumination. Since the illumination creates a heat input in the chamber, this is considered automatically when operating without illumination. This can be recognized when turning on or off the illumination by a change of the actual temperature and humidity values, which subsequently will equilibrate again to the set-points.

8.4 Light commutation and special controller functions



Press the **Setpoint setting** icon to access the “Setpoint” setting menu from Normal display.

You can define the switching state of up to 16 controller functions. They are used to activate / deactivate special controller functions.

- Controller function “Idle mode” activates / deactivates the operating mode “Idle mode”.
- Controller function “Humidification off”: Turns off humidification.
- Controller function “Dehumidification off”: Turns off dehumidification.
- Controller function “Internal light”: Activates the continuous interior light (option)
- Controller function “Door lock”: Activates the electro mechanical door lock (option)
- Controller function “Compressed air dryer”: Activates the compressed air dryer (option)
- Controller function “Object temp. control”: Activates the object temperature control (option)
- Controller function “Light UVA”: Activates the UVA lighting
- Controller function „Light VIS“: Activates the LED lighting
- Controller function “LQC ON”: Activates the light integration function
- Controller function “LQC RESET UVA”: Resets to zero the integrated UVA dose value
- Controller function “LQC RESET VIS”: Resets to zero the integrated VIS dose value

The other controller functions are without function.

Use the “Setpoints” menu to configure the special controller functions.

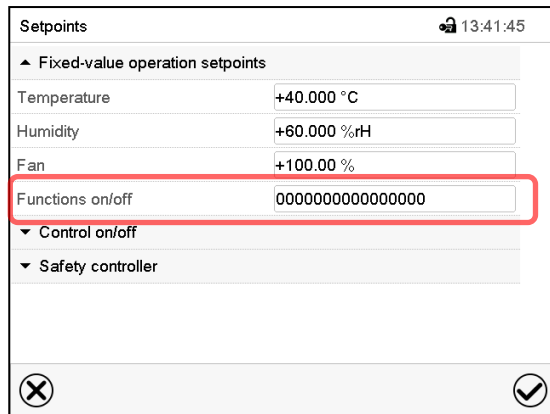

“Setpoints” menu.

Select the field “Functions on/off”.

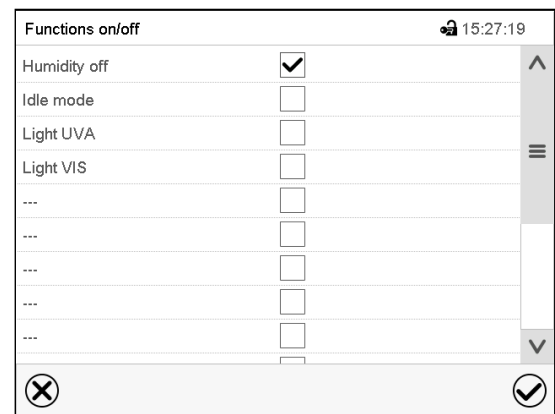

“Functions on/off” entry menu (example).

Mark / unmark the checkbox to activate / deactivate the desired function and press the **Confirm** icon

Activated controller function: switching status “1” (On)

Deactivated controller function: switching status “0” (Off)

The controller functions count from right to left.

Example:

Activated controller function “Idle mode” = 0000000000000000**1**

Deactivated controller function “Idle mode” = 0000000000000000**0**

9. Time programs

The MB2 program controller permits programming time programs with real-time reference. It offers 25 program memory positions with up to 100 program sections each. Hot-air disinfection is always program 1.

For each program section you can enter set-points for temperature, humidity, fan speed, illumination, section duration, type of set-point transition (ramp or step) and the tolerance ranges.

With Quantum Control: By accordingly programming the special controller functions, light integration is possible (chap. 9.1.1).

Programming remains saved in case of a power failure or after turning off the unit.

Path: [Main menu](#) > [Programs](#) > [Time program](#)

9.1 Value entry for a program section

Path: [Main menu](#) > [Programs](#) > [Time program](#)

Select the desired program and section.

The section view gives access to all parameters of a program section. You can enter or modify the values.

<p>Programm 1 - Abschnittsnummer 1 🔒 17:30:13</p> <p>Dauer <input type="text" value="00:00:01"/> ▲</p> <p>Verlauf <input type="text" value="Rampe"/> ▼</p> <p>Funktionen ein/aus <input type="text" value="0000000000000000"/></p> <p>Anzahl Wiederholungen <input type="text" value="0"/> ≡</p> <p>Startabschnitt für Wiederholung <input type="text" value="1"/></p> <p>Temperatur <input type="text" value="+70,000"/></p> <hr/> <p>Toleranzband Min. <input type="text" value="+0,0000"/></p> <p>Toleranzband Max. <input type="text" value="+0,0000"/></p> <p>Feuchte <input type="text" value="+80,000"/> ≡</p> <p>Toleranzband Min. <input type="text" value="+0,0000"/></p> <p>Toleranzband Max. <input type="text" value="+0,0000"/></p> <p>Lüfter <input type="text" value="+100,00"/> ▼</p> <p>⊗ <input type="text"/> <input type="text"/> ✓</p>	<p>Program name and section number</p> <p>Section duration</p> <p>Type of setpoint transition: ramp or step</p> <p>Special controller functions</p> <p>Repeating one or several sections within a program</p> <p>Temperature set-point</p> <p>Temperature tolerance range: minimum and maximum</p> <p>Humidity set-point</p> <p>Humidity tolerance range: minimum and maximum</p> <p>Fan speed set-point</p>
<p>Display without Quantum Control (example)</p>	

<p>Programm 3 - Abschnittsnummer 1 🔒 15:00:58</p> <p>Dauer <input type="text" value="00:00:01"/> ▲</p> <p>Verlauf <input type="text" value="Rampe"/> ▼</p> <p>Funktionen ein/aus <input type="text" value="0000000000000000"/></p> <p>Anzahl Wiederholungen <input type="text" value="0"/> ≡</p> <p>Startabschnitt für Wiederholung <input type="text" value="1"/></p> <p>Temperatur <input type="text" value="+70,000"/></p> <p>Toleranzband Min. <input type="text" value="+0,0000"/></p> <p>Toleranzband Max. <input type="text" value="+0,0000"/></p> <p>Feuchte <input type="text" value="+80,000"/> X</p> <p>Toleranzband Min. <input type="text" value="+0,0000"/></p> <p>Toleranzband Max. <input type="text" value="+0,0000"/></p> <p>Lüfter <input type="text" value="+100,00"/></p> <p>UVA Dosis <input type="text" value="+999,00"/></p> <p>Toleranzband Min. <input type="text" value="+0,0000"/></p> <p>Toleranzband Max. <input type="text" value="+0,0000"/></p> <p>VIS Dosis <input type="text" value="+999,00"/> ≡</p> <p>Toleranzband Min. <input type="text" value="+0,0000"/></p> <p>Toleranzband Max. <input type="text" value="+0,0000"/> ▼</p> <p>⊗ <input type="text"/> <input type="text"/> ✓</p>	<p>Program name and section number</p> <p>Section duration</p> <p>Type of setpoint transition: ramp or step</p> <p>Special controller functions</p> <p>Repeating one or several sections within a program</p> <p>Temperature set-point</p> <p>Temperature tolerance range: minimum and maximum</p> <p>Humidity set-point</p> <p>Humidity tolerance range: minimum and maximum</p> <p>Fan speed set-point</p> <p>UVA set-point</p> <p>UVA dose tolerance range: minimum and maximum</p> <p>VIS set-point</p> <p>VIS dose tolerance range: minimum and maximum</p>
<p>Display with Quantum Control (example)</p>	

The setting and control ranges for the individual parameters are the same as for “Fixed value” operating mode (chap. 8).

9.1.1 Light commutation and special controller functions

You can define the switching state of up to 16 controller functions. They are used to activate / deactivate special controller functions.

- Controller function “Idle mode” activates / deactivates the operating mode “Idle mode”.
- Controller function “Humidification off”: Turns off humidification.
- Controller function “Dehumidification off”: Turns off dehumidification.
- Controller function “Internal light”: Activates the continuous interior light (option)
- Controller function “Door lock”: Activates the electro mechanical door lock (option)
- Controller function “Compressed air dryer”: Activates the compressed air dryer (option)
- Controller function “Object temp. control”: Activates the object temperature control (option)
- Controller function “Light UVA”: Activates the UVA lighting
- Controller function „Light VIS“: Activates the LED lighting
- Controller function “LQC ON”: Activates the light integration function
- Controller function “LQC RESET UVA”: Resets to zero the integrated UVA dose value
- Controller function “LQC RESET VIS”: Resets to zero the integrated VIS dose value

The other controller functions are without function.

Use the setting “Functions on/off” to configure the special controller functions.

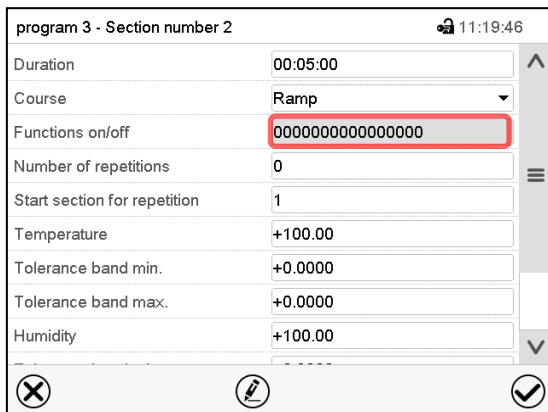

Section view.

Select the field “Functions on/off”.

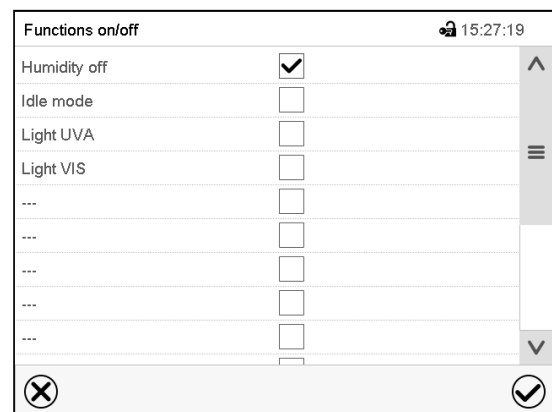
“Functions on/off” entry menu without Quantum Control

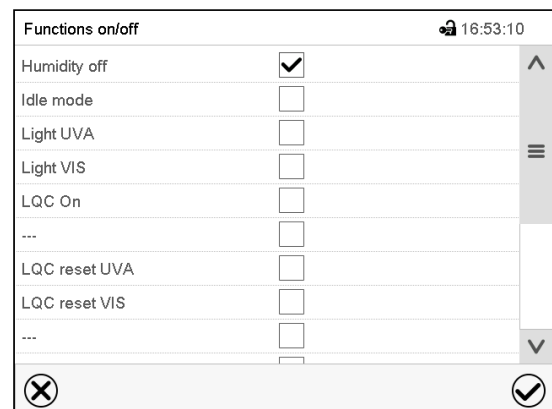

“Functions on/off” entry menu with Quantum Control

program 3 - Section number 2		🔒 11:27:18
Duration	00:05:00	↑
Course	Ramp	▼
Functions on/off	0000000000000001	
Number of repetitions	0	☰
Start section for repetition	1	
Temperature	+100.00	
Tolerance band min.	+0.0000	
Tolerance band max.	+0.0000	
Humidity	+100.00	↓

✕ ✎ ☑

Section view indicating the controller functions

Activated controller function: switching status “1” (On)

Deactivated controller function: switching status “0” (Off)

The controller functions count from right to left.

Example:

Activated controller function “Idle mode” = 0000000000000001

Deactivated controller function “Idle mode” = 0000000000000000

9.1.2 Setpoint entry

- Select the field “Temperature” and enter the desired temperature setpoint.
KBF / KBF-UL setting range: -5 °C up to 70 °C, KBF PRO setting range: -20 °C up to 100 °C.
Confirm entry with **Confirm** icon. The controller returns to the section view.
- Select the field “Humidity” and enter the desired humidity setpoint.
KBF / KBF-UL setting range: 0% r.h. up to 80% r.h., KBF PRO setting range: 0% r.h. up to 100% r.h.
Confirm entry with **Confirm** icon. The controller returns to the section view.
- Select the field “Fan” and enter the desired fan speed setpoint.
Setting range: 40% up to 100% fan speed.
Confirm entry with **Confirm** icon. The controller returns to the section view.

Chambers with Quantum Control only:

- Select the field “UVA Dose” and enter the desired target dose.
Setting range: 0.0 Wh/m² up to 99999 Wh/m².
Confirm entry with **Confirm** icon. The controller returns to the section view.
- Select the field “VIS Dose” and enter the desired target dose.
Setting range: 0.0 MLUXh up to 99999 MLUXh.
Confirm entry with **Confirm** icon. The controller returns to the section view.

9.1.3 Tolerance range

For temperature and humidity and, with Quantum Control, for the VIS and UVA dose, you can specify a tolerance range for each program section with different values for the tolerance minimum and maximum. When the actual value exceeds the given threshold, the program is interrupted. This is indicated on the display (see below). When the actual temperature is situated again within the entered tolerance limits, the program automatically continues. Therefore, the duration of the program may be extended due to the programming of tolerances.



Programming of tolerances may extend program duration.

An entry of “-99999” for the tolerance minimum means “minus infinite” and an entry of “999999” for the tolerance maximum means “plus infinite”. Entry of these values will never lead to program interruption. The entry of “0” for the tolerance minimum and/or maximum deactivates the respective tolerance function.

When requesting rapid value transitions, we recommend not programming tolerance values in order to enable the maximum heating-up, cooling-down, humidification or dehumidification speed.

program 3 - Section number 2		🔒 11:27:18
Duration	00:05:00	⬆
Course	Ramp	⬇
Functions on/off	0000000000000001	
Number of repetitions	0	☰
Start section for repetition	1	
Temperature	+100.00	
Tolerance band min.	+0.0000	
Tolerance band max.	+0.0000	
Humidity	+100.00	⬇

Section view, showing the temperature tolerance band

- Select the field “Tolerance band min” and enter the desired lower tolerance band value. Setting range: -99999 to 99999. Confirm entry with **Confirm** icon. The controller returns to the section view.
- Select the field “Tolerance band max” and enter the desired upper tolerance band value. Setting range: -99999 to 99999. Confirm entry with **Confirm** icon. The controller returns to the section view.

Set the tolerance ranges for other parameters accordingly, if desired.

If one of the actual values (temperature and/or humidity) is outside the program tolerance range the whole program course is interrupted. During this program interruption time the controller equilibrates to the set-points of the current section.

The screen header indicates “Program pause (tolerance band)”. The program runtime indication flashes and does not proceed any further.

When the temperature or humidity values are back within the entered program tolerance range, the program continues automatically.

10. Week programs

The MB2 program controller permits programming week programs with real-time reference. It offers 5 week program places in total with up to 100 shift points for each week program.

Path: [Main menu > Programs > Week program](#)

With Quantum Control: By programming the controller functions accordingly, light integration is possible (chap. 10.1.2).

10.1 Value entry for a program section

Path: [Main menu > Programs > Week program](#)

Select the desired program and section.

The setting and control ranges for the individual parameters are the same as for “Fixed value” operating mode (chap. 8).

10.1.1 Setpoint entry

- Select the field “Temperature” and enter the desired temperature setpoint.
KBF / KBF-UL setting range: -5 °C up to 70 °C, KBF PRO setting range: -20 °C up to 100 °C.
Confirm entry with **Confirm** icon. The controller returns to the section view.
- Select the field “Humidity” and enter the desired humidity setpoint.
KBF / KBF-UL setting range: 0% r.h. up to 80% r.h., KBF PRO setting range: 0% r.h. up to 100% r.h.
Confirm entry with **Confirm** icon. The controller returns to the section view.
- Select the field “Fan” and enter the desired fan speed setpoint.
Setting range: 40% up to 100% fan speed.
Confirm entry with **Confirm** icon. The controller returns to the section view.

For chambers with Quantum Control only:

- Select the field “UVA Dose” and enter the desired target dose.
Setting range: 0.0 Wh/m² up to 99999 Wh/m².
Confirm entry with **Confirm** icon. The controller returns to the section view
- Select the field “VIS Dose” and enter the desired target dose.
Setting range: 0.0 MLUXh up to 99999 MLUXh.
Confirm entry with **Confirm** icon. The controller returns to the section view

10.1.2 Light commutation and special controller functions

You can define the switching state of up to 16 controller functions. They are used to activate / deactivate special controller functions.

- Controller function “Idle mode” activates / deactivates the operating mode “Idle mode”.
- Controller function “Humidification off”: Turns off humidification.
- Controller function “Dehumidification off”: Turns off dehumidification.
- Controller function “Internal light”: Activates the continuous interior light (option)
- Controller function “Door lock”: Activates the electro mechanical door lock (option)
- Controller function “Compressed air dryer”: Activates the compressed air dryer (option)

- Controller function “Object temp. control”: Activates the object temperature control (option)
- Controller function “Light UVA”: Activates the UVA lighting
- Controller function „Light VIS“: Activates the LED lighting
- Controller function “LQC ON”: Activates the light integration function
- Controller function “LQC RESET UVA”: Resets to zero the integrated UVA dose value
- Controller function “LQC RESET VIS”: Resets to zero the integrated VIS dose value

The other controller functions are without function.

Select the desired program and section. You can set the controller functions in the “Functions on/off” field.

For details please refer to chap. 9.1.1.

11. Alarm functions

11.1.1 Messages when reaching a dose target value – ICH Q1B light module with Quantum Control

Fixed value		LQC VIS UVA ▾ 16:48:07 ▾	
		Setpoint	Actual value
Temperature	°C	20.0	20.0
Humidity	%RH	60.0	60.0
VIS dose	Wh/m ²	1.00	0.00
UVA dose	MLUXh	1.00	0.00

☰
🔔
📄
👉
▶
ℹ
🏠
➡

When the VIS target dose is reached the corresponding line in Normal Display is highlighted in green, and the message “VIS dose reached” is displayed in the event list.

When the UVA target dose is reached the corresponding line in Normal Display is highlighted in green, and the message “UVA dose reached” is displayed in the event list.

As soon as the second target dose is reached as well, in addition the alarm message “VIS and UVA doses reached” is displayed, and a buzzer sounds. The alarm can be acknowledged on the controller. The alarm message is displayed in the event list.

11.1.2 Alarm messages

Condition	Alarm message	Start after condition occurred	Zero-voltage relay alarm output (option)
The current actual temperature value is outside the tolerance range	"Temperature range alarm"	after configurable time	time as alarm start
The current actual humidity value is outside the tolerance range	"Humidity range alarm"	after configurable time	time as alarm start
Open chamber door	"Door open"	after 5 minutes	----
Power failure	---	----	immediately
Setpoint of the safety controller exceeded	"Safety controller(high)"	immediately	----
Setpoint of the safety controller fallen below	"Safety controller(low)"	immediately	----
Door sensor defective	"Door sensor"	immediately	
Temperature sensor defective	e.g. "- - - -" or "<-<-<" or ">->->"	immediately	----
Safety controller temperature sensor defective	"Safety controller sensor"	immediately	----
Dose target value VIS reached	"UVA dose reached"	immediately	----
Dose target value UVA reached	"VIS dose reached"	immediately	----
Both dose target values VIS and UVA reached	"VIS and UVA doses reached"	immediately	----
Light sensor for UVA or VIS connected and current set-point above 60 °C / 140 °F: maximum temperature limited to 60 °C / 140 °F	"Light sensor 60 °C"	immediately	----
Patch cable for the data connection between Q1B light box and cooling incubator/climate chamber not connected or power supply of Q1B light box not connected or Q1B light box not turned on	"ICH module"	immediately	----
At least one light cassette connected and activated via controller function, and current set-point above 60 °C / 140 °F: maximum temperature limited to 60 °C / 140 °F	"Light cassette 60°C!"	immediately	----
Light sensor UVA not connected, interchanged or defective	"Light sensor (UVA) "	immediately	----
Light sensor VIS not connected, interchanged or defective	"Light sensor (VIS) "	immediately	----

Alarm messages are displayed in the list of active alarms until acknowledging them. They are also shown in the event list.



12. ICH compliant illumination according to CPMP/ICH/279/95 (Q1B)

Drugs are tested according to extensive test procedures and only thereafter are admitted for distribution. Part of the approval procedure is the proof that the products do not or only minimally change within the serviceable life. One of the tests to be executed is the photostability test according to ICH guideline Q1B. For this test, product samples must be exposed to a quantity of light of at least 1.2 million LUX x hours in constant climate chambers with ICH compliant illumination. To prove the quantity of light a temporal integration of illumination (LUX) and UV intensity (W/m^2) e.g. by optical sensors is needed.

Pure cool white LEDs are used together with the UVA fluorescent tubes. This combination leads to a spectral distribution according to option 2 of Guideline CPMP/ICH/279/95 (Q1B).

Advantages of the BINDER light system:

- After having reached the target intensity of guideline CPMP/ICH/279/95 (Q1B), you can turn off the UVA fluorescent tubes independently of the illumination in the visible spectral range.
- Optimum homogeneity of the spectral distribution and the intensities in LUX and UVA on the shelf surface, even with high intensity values. This guarantees that all samples receive the same radiation doses, thus permitting very precise test conditions for photo stability tests.

	 WARNING
<p>Danger of eye and skin injury by UV light hazard. Eye and skin injury.</p> <ul style="list-style-type: none"> ⊘ DO NOT look directly into the radiation. ➤ Keep skin exposure to radiation as low as possible. ➤ Wear UVA protective goggles when opening the door of the cooled incubator/climate chamber when the light is on 	

KBF/KBF PRO: The waste heat from the fluorescent tubes leads to a change in the temperature-humidity diagram.

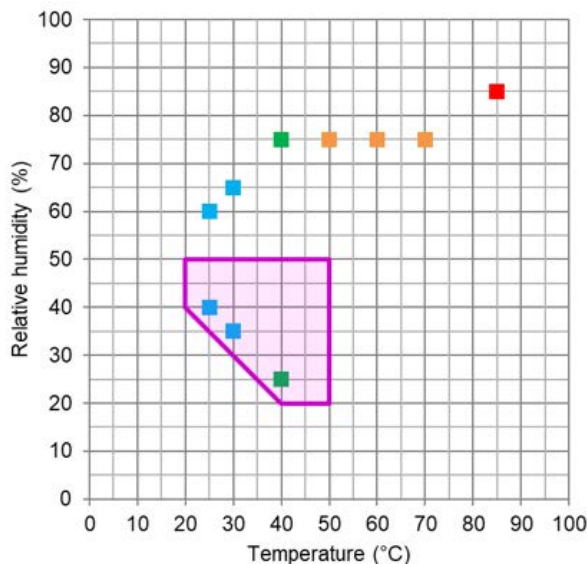

KBF/KBF-UL temperature-humidity diagram

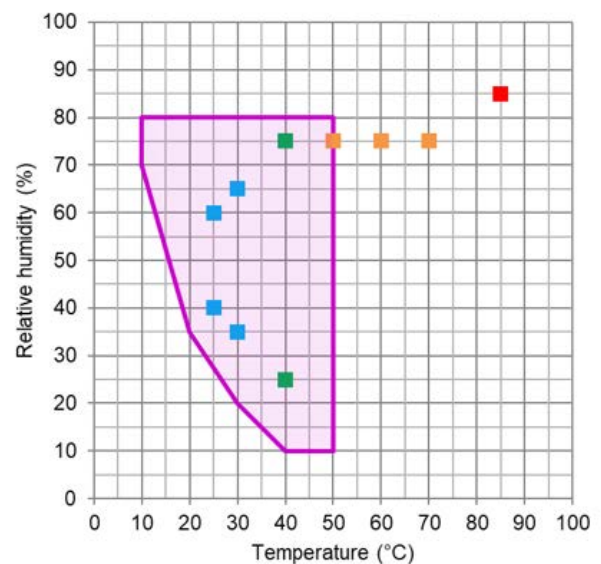

KBF PRO temperature-humidity diagram

Figure 19: Modified temperature-humidity diagrams with ICH Q1B light

12.1 Adjustable light cassettes

Special reflector material in the cassettes ensures optimum light diffusion and efficient utilization of the high light intensity. The fluorescent tubes and LEDs are built in light cassettes that can be freely positioned within wide areas. They homogeneously illuminate the racks below them.



When operating the chamber with light cassettes and lighting turned on: maximum temperature 60 °C / 140 °F.

12.2 Characteristic features of the light sensors – ICH Q1B light module with Quantum Control

The sensors can be plugged to the ICH Q1B light box what makes it easy to take them out for calibration or replacement.

The intensities of illumination [LUX] and UV [W/m^2] are measured by optical sensors inside chambers with ICH illumination equipment (actual value display) and are temporally integrated (dose value display).



The measurement with Quantum Control is subject to an uncertainty of 10%. To comply with ICH requirements, it is recommended to increase the irradiation dose by 10%.

12.2.1 VIS sensor

Spectral sensitivity and spectral range are automatically determined with the unit “LUX”. The relative spectral sensitivity is the V- λ distribution according to the sensitivity characteristics of the human eye.

- Display of the actual value in kLUX
- Display of the dose: The value “1” equals an integrated illumination of 1 MLUXh. Therefore values from 0 to 999.9 MLUXh can be displayed on a four-place display (0-999.9). A controller value of 1.2 equals 1.2 Mio. LUXh. With e.g., 11 kLUX it will therefore take the dose display about 9 hours to increase by 0.1.

12.2.2 UVA sensor

The UVA sensors must take into account the spectral range between 320 and 400 nm, which is defined in ICH guideline Q1B, Option 2.

- Display of the actual value in W/m^2
- Display of the dose: The value 1 equals an integrated illumination 1 Wh/m^2 (equaling 0.36 J/cm^2). Therefore values from 0 to 999.9 Wh/m^2 can be displayed on a four-place display (0-999.9). A controller value of 200.0 equals 200.0 Wh/m^2 . With e.g., 7 W/m^2 it will therefore take the display unit about 8.6 minutes to increase by 0.1.

12.2.3 Spectral range

The spectral sensitivities of both sensors are adapted to the spectral ranges defined in the ICH guideline Q1B, Option 2.

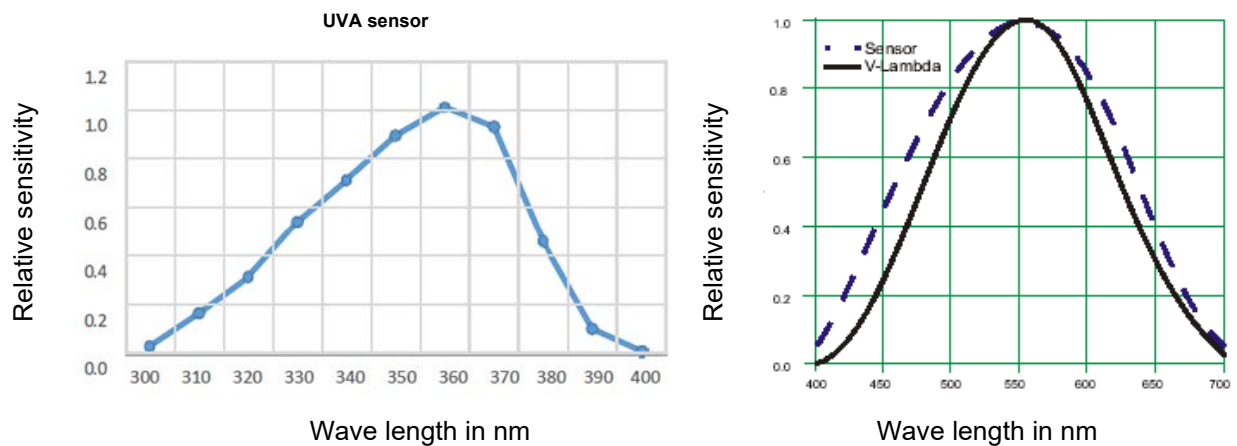

Figure 20: Relative spectral sensitivities

12.2.4 Spatial sensitivity

Spherical sensors are used for UVA and the visible spectral range.

Thus, the spatial sensitivity of the detectors is adapted to the spatial effect of radiation in relation to the photochemical effect to be weighted in the charging material. Due to the spatial extension of the sample, the real impinging radiation dose can be determined much more realistic than with planar (cosine adapted) sensors.

Characteristic features of spherical sensors

Compared to planar (cosine adapted) sensors, spherical sensors measure largely independent of direction. They are suitable for all samples with spatial extension and spatially distributed objects (e.g. bottles and other vessels, pills, dissolved substances). Here, the radiation intensity or illumination really entering the sample can be realistically determined with spherically measuring light sensors. The energy entering the sample in the visible, and UV range is thus weighted in optimal approximation to its real photochemical effects.

Use of planar sensors with spatial objects leads to underrating of the radiation energy, leading to excessive exposure duration and possible false positive photochemical effects. The ICH guideline Q1B proposes actinometric systems in glass ampoules as a reference for exposition to radiation; the photochemical effect to a defined test solution caused by radiation exposure is photometrically determined. Here, the photochemical effect is determined independent of direction using a liquid in an ampoule. The use of the spherical sensors in the BINDER measurement system imitates this quantification of the photochemically effective radiation in the best approximation. It enables and permits an exposition exactly responding to the demands of ICH guideline Q1B.



Figure 21: Spherical BINDER sensors for VIS, and UVA measurement

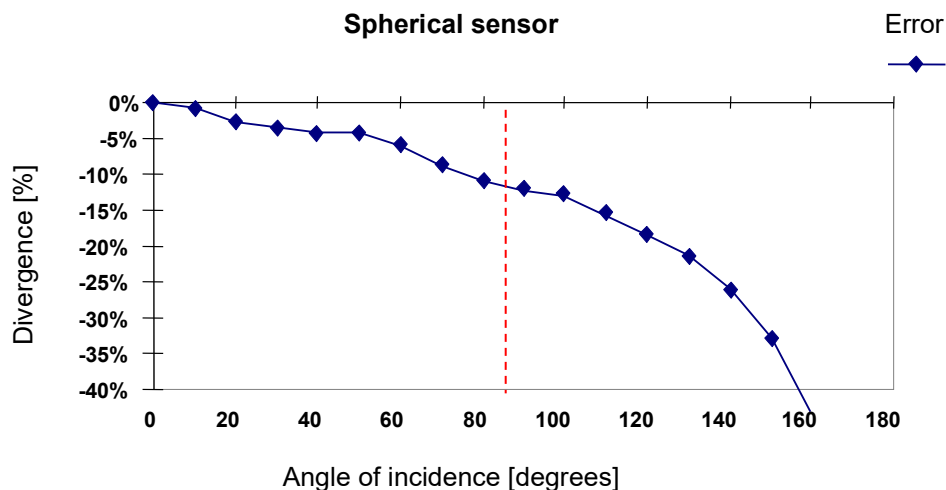

Radiation in a range of +/- 100° around the 90° axis of incidence is weighted almost equally with a factor between 1.0 and 0.9. Only with greater angles, weighting of the radiation decreases, technically caused by the sensor foot.

Comparison of different sensor types

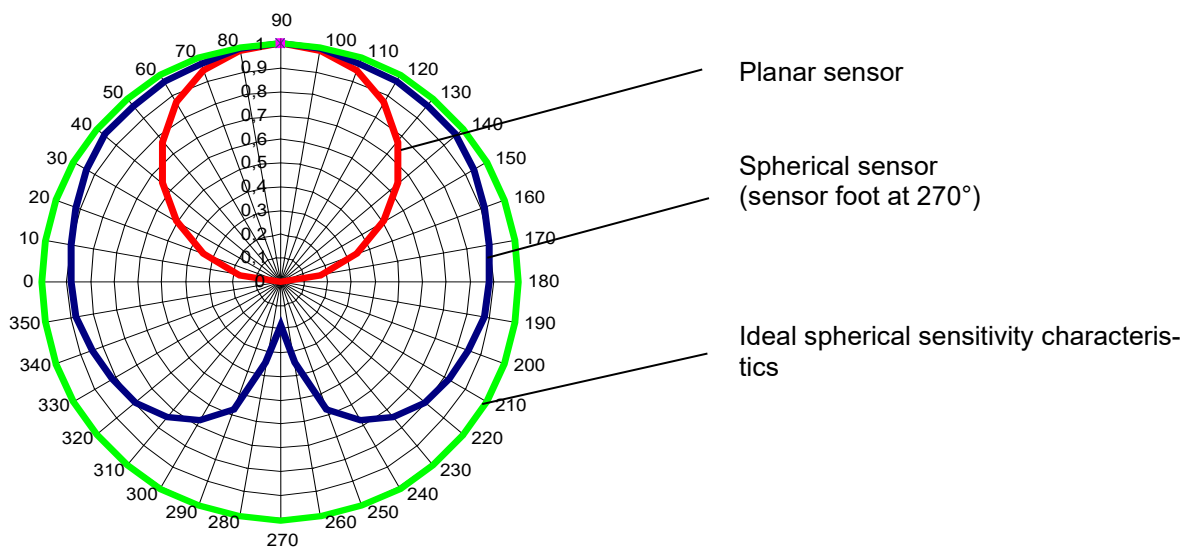
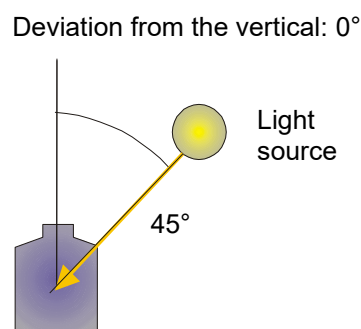



Figure 22: Comparison of the spatial sensitivity characteristics of planar and spherical sensors

If a sample is irradiated with light at an angle of incidence of 45°, the spherical sensor assumes the impinging light quantity as large as the amount of light that would impinge with vertical irradiation (factor 1). Since this is true for a sample with spatial extension, the error is zero in this case.

A planar sensor instead would take into account the cosine of the angle of incidence, e.g. $\cos 45$. But due to the spatial extension of the sample, this cosine weighting isn't necessary.





	<p>In case of exclusive use of entirely flat samples without spatial extension (e.g. spreaded samples, film), an overrating of the light which really impinges on the plane surface is possible. A first estimate of the planar measurement values can be made by multiplying by a factor of 0.6. If this estimate is not sufficient for you, please contact BINDER Service for further solutions by BINDER INDIVIDUAL customized solutions.</p>
---	--

	<p>If an independent reference measuring device shall be used to directly compare the light intensities, it must bear the same spatial sensitivity characteristics (spherical) as the sensors of the BINDER system.</p>
---	---

13. Cleaning and decontamination

Clean the chamber after each use in order to prevent potential corrosion damage by ingredients of the loading material.

Prior to renewed startup, allow the chamber to completely dry after all cleaning and decontamination measures.

	<div style="background-color: red; color: white; padding: 5px; text-align: center;">  DANGER </div> <p>Electrical hazard by water entering the chamber. Deadly electric shock.</p> <ul style="list-style-type: none"> Ø Do NOT spill water or cleaning agents over the inner and outer chamber surfaces. Ø Do NOT put ANY cleaning aids (cloth or brush) into slots or openings on the chamber. ➤ Before cleaning, turn off the cooling incubator/climate chamber at the On/Off switch (H) and disconnect the power plug. Let the chamber cool down to ambient temperature. ➤ Before cleaning, turn off the chamber and the ICH Q1B light box and disconnect the power plugs. Let the chamber cool down to ambient temperature. ➤ Completely dry the chamber and accessory before turning it on again.
--	---

13.1 Cleaning

Disconnect the chamber from the power supply before cleaning. Pull the power plug.

	<p>The interior of the chamber must be kept clean. Thoroughly remove any residues of test material.</p>
---	---

Wipe the surfaces with a moistened towel. In addition, you can use the following cleaning agents:

<p>Exterior surfaces of the ICH Q1B light box, housing of the light cassettes</p>	<p>Standard commercial cleaning detergents free from acid or halides. Alcohol-based solutions. We recommend using the neutral cleaning agent Art. No. 1002-0016.</p>
<p>Instrument panel</p>	<p>Standard commercial cleaning detergents free from acid or halides. We recommend using the neutral cleaning agent Art. No. 1002-0016.</p>
<p>Light sensors</p>	<p>Wipe with a soft, if desired moistened towel. Do not mechanically strain the light sensors during cleaning and take care not to scratch them.</p>
<p>Fluorescent tubes</p>	<p>Wipe the surfaces with a moistened towel. Do not use cleaning agents.</p>
<p>LED boards</p>	<p>Clean the LEDs only with isopropyl alcohol.</p>

Do not use cleaning agents that may cause a hazard due to reaction with components of the device or the loading material. If there is doubt regarding the suitability of cleaning products, please contact BINDER service.

	<p>We recommend using the neutral cleaning agent Art. No. 1002-0016 for a thorough cleaning. Any corrosive damage that may arise following use of other cleaning agents is excluded from liability by BINDER GmbH.</p> <p>Any corrosive damage caused by a lack of cleaning, is excluded from liability by BINDER GmbH.</p>
---	---

	<p style="text-align: center;">NOTICE</p> <p>Danger of corrosion by using unsuitable cleaners. Damage to the accessory.</p> <ul style="list-style-type: none"> ∅ Do NOT use acidic or chlorine cleaning detergents. ∅ Do NOT use a neutral cleaning agent on other kind of surfaces (e.g., light sensors, LED lighting).
---	--

	<p>For surface protection, perform cleaning as quickly as possible. After cleaning completely remove cleaning agents from the surfaces with a moistened towel. Let the chamber dry.</p>
---	---



	<p>Soapsuds may contain chlorides and must therefore NOT be used for cleaning.</p>
--	--

	<p>With every cleaning method, always use adequate personal safety controls.</p>
---	--

Following cleaning, leave the chamber door open or remove the access port plugs.

	<p>The neutral cleaning agent may cause health problems in contact with skin and if ingested. Follow the operating instructions and safety hints labeled on the bottle of the neutral cleaning agent.</p>
---	---

Recommended precautions: To protect the eyes use sealed protective goggles. Wear gloves. Suitable protective gloves in full contact with media: butyl or nitrile rubber, penetration time >480 minutes.

	<p style="text-align: center;"> CAUTION</p> <p>Danger of chemical burns through contact with skin or ingestion of the neutral cleaning agent. Skin and eye damage. Environmental damage.</p> <ul style="list-style-type: none"> ∅ Do not ingest the neutral cleaning agent. Keep it away from food and beverages. ∅ Do NOT empty the neutral cleaning agent into drains. ➤ Wear protective gloves and goggles. ➤ Avoid skin contact with the neutral cleaning agent.
---	---

13.2 Decontamination / chemical disinfection

The operator must ensure that proper decontamination is performed in case a contamination of the chamber by hazardous substances has occurred.

Disconnect the chamber from the power supply prior to chemical decontamination. Pull the power plug.

Do not use decontamination agents that may cause a hazard due to reaction with components of the device or the loading material. If there is doubt regarding the suitability of cleaning products, please contact BINDER service.

You can use the following disinfectants:

Exterior surfaces of the ICH Q1B light box, housing of the light cassettes	Standard commercial surface disinfectants free from acid or halides. Alcohol-based solutions. We recommend using the disinfectant spray Art. No. 1002-0022.
--	---

	For chemical disinfection, we recommend using the disinfectant spray Art. No. 1002-0022. Any corrosive damage that may arise following use of other disinfectants is excluded from liability by BINDER GmbH.
---	--

	With every decontamination / disinfection method, always use adequate personal safety controls.
---	---

In case of contamination of the interior by biologically or chemically hazardous material, there are two possible procedures depending on the type of contamination and loading material:



1. Spray the inner chamber with an appropriate disinfectant.

Before start-up, the chamber must be absolutely dry and ventilated, as explosive gases may form during the decontamination process.

2. If necessary, have strongly contaminated inner chamber parts removed by an engineer for cleaning, or have them exchanged. Sterilize the inner chamber parts in a sterilizer or autoclave.

	In case of eye contact, the disinfectant spray may cause eye damage due to chemical burns. Follow the operating instructions and safety hints labeled on the bottle of the disinfectant spray.
---	--

Recommended precautions: To protect the eyes use sealed protective goggles.

	<div style="background-color: yellow; text-align: center; padding: 5px;"> CAUTION</div> <p>Danger of chemical burns through eye contact with the disinfectant spray. Eye damage. Environmental damage</p> <ul style="list-style-type: none"> ⊘ Do NOT empty the disinfectant into drains. ➤ Wear protective goggles.
---	---

	After using the disinfectant spray, allow the device to dry thoroughly, and aerate it sufficiently.
---	---

14. Maintenance and service, troubleshooting, repair, testing

14.1 General information, personnel qualification

- **Maintenance**

See chap. 14.2

- **Simple troubleshooting**

Chap. 14.3 describes troubleshooting by operating personnel. It does not require technical intervention into the chamber, nor disassembly of chamber parts.

For personnel requirements please refer to chap. 1.1.

- **Detailed troubleshooting**

If errors cannot be identified with simple troubleshooting, further troubleshooting must be performed by BINDER Service or by BINDER qualified service partners or technicians.

- **Repair**



Repair of the chamber can be performed by BINDER Service or by BINDER qualified service partners or technicians.

After maintenance, the chamber must be tested prior to resuming operation.

- **Electrical testing**

To prevent the risk of electrical shock from the electrical equipment of the chamber, an annual repeat inspection as well as a test prior to initial startup and prior to resuming operation after maintenance or repair, are required. This test must meet the requirements of the competent public authorities. We recommend testing under EN 50678/VDE 0701 and EN 50699/VDE 0702.

14.2 Maintenance intervals, service

 	 DANGER
	<p>Electrical hazard during live maintenance work. Deadly electric shock.</p> <ul style="list-style-type: none"> Ø The chamber must NOT become wet during operation or maintenance works. Ø Do NOT remove the rear panel of the chamber. ➤ Disconnect the cooling incubator/climate chamber before conducting maintenance work. Turn off the On/Off switch (H) and pull the power plug. ➤ Turn off the ICH Q1B light box and pull the power plug. ➤ Make sure that general maintenance work will be conducted by licensed electricians or experts authorized by BINDER.

Ensure regular maintenance work is performed at least once a year and that the legal requirements are met regarding the qualifications of service personnel, scope of testing and documentation..

	The warranty becomes void if maintenance work is conducted by non-authorized personnel.
---	---

We recommend taking out a maintenance agreement. Please consult BINDER Service:

BINDER telephone hotline:	+49 (0) 7462 2005 555
BINDER fax hotline:	+49 (0) 7462 2005 93555
BINDER service hotline USA:	+1 866 885 9794 or +1 631 224 4340 x3 (toll-free in the USA)
BINDER service hotline Asia Pacific:	+852 390 705 04 or +852 390 705 03
BINDER Internet website	http://www.binder-world.com
BINDER address	BINDER GmbH, post office box 102, 78502 Tuttlingen, Germany

International customers, please contact your local BINDER distributor.

14.2.1 Replacement of the UVA fluorescent tubes

We recommend replacing the tubes after approximately 8,000 operating hours and at the latest after 2 years in order to ensure full light intensity.



When replacing the UVA fluorescent tubes, please note the orientation (marking).



Always replace all the fluorescent tubes of a light cassette together. Otherwise, homogeneity of light intensity cannot be ensured.

14.2.2 Replacement of the VIS LED boards

We recommend replacing the boards after approx. 25.000 operating hours and at the latest after 6 years. Please contact BINDER Service.

14.2.3 Calibrating the light sensors and adjusting the controller display (accessory with Quantum Control)

The light sensors are supplied with a calibration certificate giving at least 2 measuring values with the related measuring current values.

For recalibrating the light sensors, send the sensors to BINDER factory service.



If an independent reference measuring device is used to directly compare the light intensities, it must bear the same spatial sensitivity characteristics (spherical) as the sensors of the BINDER system (chap. 12.2.4).

14.3 Troubleshooting

Defects and shortcomings can compromise the operational safety of the chamber and can lead to risks and damage to equipment and persons. If there is a technical fault or shortcoming, take the chamber out of operation and inform BINDER Service. If you are not sure whether there is a technical fault, proceed according to the following list. If you cannot clearly identify an error or there is a technical fault, please contact BINDER Service.



Only qualified service personnel authorized by BINDER must perform repair. Repaired chambers must comply with the BINDER quality standards.

14.4 Sending the accessory back to BINDER GmbH

If you return a BINDER product to us for repair or any other reason, we will only accept the product upon presentation of an **authorization number** (RMA number) that has previously been issued to you. An authorization number will be issued after receiving your complaint either in writing or by telephone **prior** to your sending the BINDER product back to us. The authorization number will be issued following receipt of the information below:

- BINDER product type and serial number
- Date of purchase
- Name and address of the dealer from which you bought the BINDER product
- Exact description of the defect or fault
- Complete address, contact person and availability of that person
- Exact location of the BINDER product in your facility
- A contamination clearance certificate (chap. 18) must be faxed in advance

The authorization number must be applied to the packaging in such a way that it can be easily recognized or be recorded clearly in the delivery documents.



For security reasons we cannot accept a chamber delivery if it does not carry an authorization number.

Return address: BINDER GmbH Gänsäcker 16
Abteilung Service 78502 Tuttlingen, Germany

15. Disposal

15.1 Disposal of the transport packing

Packing element	Material	Disposal
Transport box with metal clamps	Cardboard	Paper recycling
	Metal	Metal recycling
Top cover	Cardboard	Paper recycling
Edge protection	Styropor® or PE foam	Plastic recycling
Bag for operating manual	PE foil	Plastic recycling
Insulating air cushion foil	PE foil	Plastic recycling

If recycling is not possible, all packing parts can also be disposed of with normal waste.

15.2 Decommissioning

- Turn off the cooling incubator/climate chamber at the main power switch and disconnect it from the power supply (pull the power plug).
- Turn off the ICH Q1B light box and disconnect it from the power supply (pull the power plug).
- Temporal decommissioning: See indications for appropriate storage.
- Final decommissioning: Dispose of the chamber as described in chap. 15.3 to 15.5.

15.3 Disposal of the accessory in the Federal Republic of Germany

According to Annex I of Directive 2012/19/EU of the European Parliament and of the Council on waste electrical and electronic equipment (WEEE), BINDER devices are classified as “monitoring and control instruments” (category 9) only intended for professional use”. They must not be disposed of at public collecting points.

The accessory bears the symbol for the marking of electrical and electronic equipment manufactured / placed on the market in the EU after 13 August 2005 and be disposed of in separate collection according to Directive 2012/19/EU on waste electrical and electronic equipment (WEEE) and German national law for electrical and electronic equipment (Elektro- und Elektronikgerätegesetz, ElektroG). WEEE marking: crossed-out wheeled bin. A significant part of the materials must be recycled in order to protect the environment.

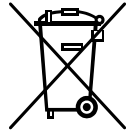



At the end of the device's service life, have the accessory disposed of according to the German national law for electrical and electronic equipment (Elektro- und Elektronikgerätegesetz, ElektroG from 20 October 2015, BGBl. I p. 1739) or contact BINDER service who will organize taking back and disposal of the chamber according to the German national law for electrical and electronic equipment (Elektro- und Elektronikgerätegesetz, ElektroG from 20 October 2015, BGBl. I p. 1739).

	NOTICE
	<p>Danger of violation against existing law if not disposed of properly.</p> <p>Failure to comply with applicable law.</p> <ul style="list-style-type: none"> ⊘ Do NOT dispose of BINDER devices at public collecting points. ➤ Have the device disposed of professionally at a recycling company which is certified according to the German national law for electrical and electronic equipment (Elektro- und Elektronikgerätegesetz, ElektroG from 20 October 2015, BGBl. I p. 1739). <li style="text-align: center;"><i>or</i> ➤ Instruct BINDER Service to dispose of the device. The general terms of payment and delivery of BINDER GmbH apply, which were valid at the time of purchasing the chamber.

Certified companies disassemble waste (used) BINDER equipment in primary substances for recycling according to Directive 2012/19/EU. The devices must be free from toxic, infectious or radioactive substances in order to eliminate any health hazards to the employees of the recycling companies.

	<p>Prior to handing the chamber over to a recycling company, it is the user's responsibility that it is free from toxic, infectious or radioactive substances.</p> <ul style="list-style-type: none"> • Prior to disposal, clean all introduced or residual toxic substances from the chamber. • Prior to disposal, disinfect the chamber from all sources of infection. Be aware that sources of infection may also be located outside the inner chamber. • If you cannot safely remove all toxic substances and sources of infection from the chamber, dispose of it as special waste according to national law. • Fill out the contamination clearance certificate (chap. 18) and enclose it with the chamber.
---	---

 	 WARNING
	<p>Danger of intoxication and infection through contamination of the chamber with toxic, infectious or radioactive substances.</p> <p>Damages to health.</p> <ul style="list-style-type: none"> ⊘ NEVER take a chamber contaminated with toxic substances or sources of infection for recycling according to Directive 2012/19/EU. ➤ Prior to disposal, remove all toxic substances and sources of infection from the chamber. ➤ A chamber from which all toxic substances or sources of infection cannot be safely removed must be considered as “special” waste according to national law. Dispose of it accordingly.

15.4 Disposal of the accessory in the member states of the EU except for the Federal Republic of Germany

According to Annex I of Directive 2012/19/EU of the European Parliament and of the Council on waste electrical and electronic equipment (WEEE), BINDER devices are classified as “monitoring and control instruments” (category 9) only intended for professional use”. They must not be disposed of at public collecting points.

The accessory bears the symbol for the marking of electrical and electronic equipment manufactured / placed on the market in the EU after 13 August 2005 and be disposed of in separate collection according to the Directive 2012/19/EU on waste electrical and electronic equipment (WEEE). WEEE marking: crossed-out wheeled bin.

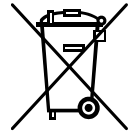



At the end of the device’s service life, notify the distributor who sold you the device, who will take back and dispose of the chamber according to the Directive 2012/19/EU on waste electrical and electronic equipment (WEEE).



	<p style="text-align: center;">NOTICE</p> <p>Danger of violation against existing law if not disposed of properly. Failure to comply with applicable law.</p> <ul style="list-style-type: none"> ⊘ Do NOT dispose of BINDER devices at public collecting points. ➤ Have the device disposed of professionally at a recycling company that is certified according to conversion of the Directive 2012/19/EU into national law. <i>or</i> ➤ Instruct the distributor who sold you the device to dispose of it. The agreements apply that were agreed with the distributor when purchasing the chamber (e.g. his general terms of payment and delivery). ➤ If your distributor is not able to take back and dispose of the chamber, please contact BINDER service.
---	--

Certified companies disassemble waste (used) BINDER equipment in primary substances for recycling according to Directive 2012/19/EU. The devices must be free from toxic, infectious or radioactive substances in order to eliminate any health hazards to the employees of the recycling companies.

	<p>Prior to handing the chamber over to a recycling company, it is the user’s responsibility that it is free from toxic, infectious or radioactive substances.</p> <ul style="list-style-type: none"> • Prior to disposal, clean all introduced or residual toxic substances from the chamber. • Prior to disposal, disinfect the chamber from all sources of infection. Be aware that sources of infection may also be located outside the inner chamber. • If you cannot safely remove all sources of infection and toxic substances from the chamber, dispose of it as special waste according to national law. • Fill out the contamination clearance certificate (chap. 18) and enclose it with the chamber.
---	---

	<p style="text-align: center;"> WARNING</p> <p>Danger of intoxication and infection through contamination of the chamber with toxic, infectious or radioactive substances. Damages to health.</p> <ul style="list-style-type: none"> ⊘ NEVER take a chamber contaminated with toxic substances or sources of infection for recycling according to Directive 2012/19/EU. ➤ Prior to disposal, remove all toxic substances and sources of infection from the chamber. ➤ A chamber from which all toxic substances or sources of infection cannot be safely removed must be considered as “special” waste according to national law. Dispose of it accordingly.
---	--

15.5 Disposal of the accessory in non-member states of the EU

 	NOTICE	
	<p>Danger of violation against existing law if not disposed of properly. Failure to comply with applicable law. Alteration of the environment.</p> <ul style="list-style-type: none"> ➤ For final decommissioning and disposal of the accessory, please contact BINDER service. ➤ Follow the statutory regulations for appropriate, environmentally friendly disposal. 	

16. Technical Data

Exterior dimensions of the ICH Q1B light box		
Length	mm / inch	597
Height	mm / inch	411
Depth	mm / inch	108
Weight		
Weight of the ICH Q1B Light box	kg / lbs.	11,6
Weight of the ICH Q1B Light box with Quantum Control	kg / lbs.	11,8
Light cassette VIS size 260/470	kg / lbs.	8,2
Light cassette UVA size 260/470	kg / lbs.	8,2
Light cassette VIS size 720	kg / lbs.	12
Light cassette UVA size 720	kg / lbs.	12
Electrical data		
System of protection acc. to EN 60529	IP	20
Nominal voltage (+/-10%) at 50 Hz power frequency	V	120-240
Nominal voltage (+/-10%) at 60 Hz power frequency	V	120-240
Current type		1N~
Power plug		Grounded plug
Nominal power	kW	0,25
Installation category acc. to IEC 61010-1		II
Pollution degree acc. to IEC 61010-1		2
Illumination data per light cassette		
ICH compliant illumination for photo stability testing, UVA fluorescent tubes	UVA W/m ²	***
ICH compliant illumination for photo stability testing, VIS LED boards	Lux	***

*** Data not yet determined

Illumination data: Average value, measured at +22 °C +/- 3 °C / 71.6 °F +/- 5.4 °F with a spherical sensor (+/-10%) by 12 cm / 4.7 in below the light cassette. The values given in W/m² refer to global radiation.

All technical data is specified for unloaded chambers with standard equipment at an ambient temperature of +22 °C +/- 3 °C / 71.6 °F +/- 5.4 °F and a power supply voltage fluctuation of +/-10%. Technical data is determined in accordance to BINDER factory standard Part 2:2015 and DIN 12880:2007.

All indications are average values, typical for chambers produced in series. We reserve the right to change technical specifications at any time.

17. Certificates and declarations of conformity

17.1 EU Declaration of Conformity



CE EU-Konformitätserklärung / EU Declaration of Conformity / Déclaration de conformité UE / Declaración de conformidad UE / Dichiarazione di conformità UE / Декларация соответствия EU

Hersteller / Manufacturer / Fabricant / Fabricante / Fabbicante / Производитель	BINDER GmbH
Anschrift / Address / Adresse / Dirección / Indirizzo / Адрес	Im Mittleren Ösch 5, 78532 Tuttlingen, Germany
Produkt / Product / Produit / Producto / Prodotto / Продукт	BINDER ICH-Q1B-Lichtmodul (mit Lichtdosissteuerung) BINDER ICH-Q1B-Light (Quantum Control) Module BINDER Module d'éclairage ICH-Q1B (avec LQC) BINDER Módulo de luz ICH-Q1B (con LQC) BINDER Modulo luci ICH-Q1B (con LQC) BINDER Модуль ICH-Q1B Light (квантовое управление)
Typenbezeichnung / Type / Type / Tipo / Tipo / Тип	Zubehör für KB PRO, KBF und KBF PRO (E7) Accessories for KB PRO, KBF and KBF PRO (E7) Accessoires pour KB PRO, KBF et KBF PRO (E7) Accesorios para KB PRO, KBF y KBF PRO (E7) Accessori per KB PRO, KBF e KBF PRO (E7) Аксессуары для KB PRO, KBF и KBF PRO (E7)
Art. No. / Art. no. / Réf. / Art. N° / Art. n. / № арт.	8012-2441 8012-2442 8012-2443 8012-2444

Die oben beschriebenen Produkte sind konform mit folgenden EU-Richtlinien:

The products described above are in conformity with the following EU Directives:

Les produits décrits ci-dessus sont conformes aux directives UE suivantes:

Los productos descritos arriba cumplen con las siguientes directivas de la UE:

I prodotti sopra descritti sono conformi alle seguenti direttive UE:

Продукты, указанные выше, полностью соответствуют следующим EU руководствам:

- **2014/35/EU**
Niederspannungsrichtlinie 2014/35/EU / Low voltage directive 2014/35/EU / Directive basse tension 2014/35/UE / Directiva sobre baja tensión 2014/35/UE / Direttiva Bassa tensione 2014/35/UE / Директива по низкому напряжению 2014/35/EU
- **2014/30/EU**
EMV-Richtlinie 2014/30/EU / EMC Directive 2014/30/EU / Directive CEM 2014/30/UE / Directiva CEM 2014/30/UE / Direttiva EMC 2014/30/UE / Директива ЭМС 2014/30/EU
- **2011/65/EU, (EU) 2015/863**
RoHS-Richtlinien 2011/65/EU und (EU) 2015/863 / RoHS Directives 2011/65/EU and (EU) 2015/863 / Directives RoHS 2011/65/UE et (UE) 2015/863 / Directivas RoHS 2011/65/UE y (UE) 2015/863 / Direttive RoHS 2011/65/UE et (UE) 2015/863 / Директивы RoHS 2011/65/EU и (EU) 2015/863

1 / 2

BINDER GmbH
Im Mittleren Ösch 5
78502 Tuttlingen
Deutschland

Tel: +49 (0) 74 62 / 20 05 - 0
Fax: +49 (0) 74 62 / 20 05 - 100
info@binder-world.com
www.binder-world.com

Geschäftsführung:
Dipl.-Ing. Peter M. Binder,
Michael Binder-Pfaff, Peter Wimmer,
Benjamin Jeuthe
Amtsgericht Stuttgart, HRB 727150
Sitz der Gesellschaft: Tuttlingen
Ust.-ID.-Nr.: DE815021304

Kreissparkasse Tuttlingen
IBAN: DE05 6435 0070 0000 0022 66
SWIFT: SOLA DE 31TUT
Deutsche Bank Tuttlingen
IBAN: DE56 6537 0075 0213 8709 00
SWIFT: DEUT DE 33653

Die oben beschriebenen Produkte tragen entsprechend die Kennzeichnung CE.
 The products described above, corresponding to this, bear the CE-mark.
 Les produits décrits ci-dessus, en correspondance, portent l'indication CE.
 Los productos descritos arriba, en conformidad, llevan la indicación CE.
 I prodotti sopra descritti, conformi a quanto sopra, portano il marchio CE.
 Данные продукты в соответствии с изложенным выше маркированы знаком CE.

Die oben beschriebenen Produkte sind konform mit folgenden harmonisierten Normen:
 The products described above are in conformity with the following harmonized standards:
 Les produits décrits ci-dessus sont conformes aux normes harmonisées suivantes:
 Los productos descritos arriba cumplen con las siguientes normas:
 I prodotti sopra descritti sono conformi alle seguenti normative armonizzate:
 Продукты, указанные выше, полностью соответствуют следующим стандартам:

2014/35/EU
<ul style="list-style-type: none"> • EN 61010-1:2010+A1:2019+A1:2019/AC:2019 • EN IEC 61010-2-012:2022 + A11:2022
2014/30/EU
<ul style="list-style-type: none"> • EN IEC 61326-1:2021
2011/65/EU, (EU) 2015/863
<ul style="list-style-type: none"> • EN IEC 63000:2018

78532 Tuttlingen, 16.12.2024
 BINDER GmbH



P. Wimmer
 Chief Technology Officer
 Chief Technology Officer (CTO)
 Directeur de la technologie
 Director de la tecnología
 Direttore tecnico
 Главный технический директор



J. Bollaender
 Leiter F & E
 Director R & D
 Chef de service R&D
 Responsable I & D
 Direttore R & D
 Глава департамента R&D

2 / 2

BINDER GmbH
 Im Mittleren Osch 5
 78502 Tuttlingen
 Deutschland

Tel: +49 (0) 74 62 / 20 05 - 0
 Fax: +49 (0) 74 62 / 20 05 - 100
 info@binder-world.com
 www.binder-world.com

Geschäftsführung:
 Dipl.-Ing. Peter M. Binder,
 Michael Binder-Pfaff, Peter Wimmer,
 Benjamin Jeuthe
 Amtsgericht Stuttgart, HRB 727150
 Sitz der Gesellschaft: Tuttlingen
 Ust.-ID.-Nr.: DE815021304

Kreissparkasse Tuttlingen
 IBAN: DE05 6435 0070 0000 0022 66
 SWIFT: SOLA DE 31TUT
 Deutsche Bank Tuttlingen
 IBAN: DE56 6537 0075 0213 8709 00
 SWIFT: DEUT DE 33653

17.2 UKCA Declaration of Conformity



	<h3>UKCA Declaration of Conformity</h3>
---	---

Name and address of manufacturer	BINDER GmbH Im Mittleren Ösch 5, 78532 Tuttlingen, Germany
Name and address of UK Authorised Representative	Comply Express Ltd Unit C2, Coalport House, Stafford Park 1, Telford TF3 3BD
Object of the Declaration	BINDER ICH-Q1B-Light (Quantum Control) Module
Type Designation	Accessories for KB PRO, KBF and KBF PRO (E7)
BINDER Art. No.	8012-2441, 8012-2442, 8012-2443, 8012-2444



The Objects of the Declaration described above are in conformity with the relevant UK Regulations and UK Guidelines:

- **Electrical Equipment (Safety) Regulations 2016**
Statutory Instruments 2016 No. 1101 – Consumer Protection Health and safety
- **Electromagnetic Compatibility Regulations 2016**
Statutory Instruments 2016 No. 1091 – Electromagnetic Compatibility
- **The Restriction of the Use of Certain Hazardous Substances in Electrical and Electronic Equipment Regulations 2012**
Statutory Instruments 2012 No. 3032 – Environmental Protection

References of standards and/or technical specifications applied for this Declaration of Conformity, or parts thereof:

S.I. 2016 No. 1101:	EN 61010-1:2010+A1:2019+A1:2019/AC:2019 EN IEC 61010-2-012:2022 + A11:2022
S.I. 2016 No. 1091:	EN IEC 61326-1:2021
S.I. 2012 No. 3032:	EN IEC 63000:2018

This Declaration is issued under the sole responsibility of the manufacturer.

	16.12.2024			
Place	Date	P. Wimmer Chief Technology Officer	J. Bollaender Director R & D	BINDER GmbH

BINDER GmbH
Im Mittleren Ösch 5
78502 Tuttlingen
Deutschland

Tel: +49 (0) 74 62 / 20 05 - 0
Fax: +49 (0) 74 62 / 20 05 - 100
info@binder-world.com
www.binder-world.com

Geschäftsführung:
Dipl.-Ing. Peter M. Binder
Michael Binder-Pfaff, Peter Wimmer,
Benjamin Jeuthe
Amtsgericht Stuttgart, HRB 727150
Sitz der Gesellschaft: Tuttlingen
Ust.-ID.-Nr.: DE815021304

Kreissparkasse Tuttlingen
IBAN: DE05 6435 0070 0000 0022 66
SWIFT: SOLA DE 31TUT
Deutsche Bank Tuttlingen
IBAN: DE56 6537 0075 0213 8709 00
SWIFT: DEUT DE 33653

18. Contamination clearance certificate

18.1 For chambers located outside USA and Canada

Declaration regarding safety and health

Erklärung zur Sicherheit und gesundheitlichen Unbedenklichkeit

The German Ordinance on Hazardous Substances (GefStofV), and the regulations regarding safety at the workplace, require that this form be filled out for all products that are returned to us, so that the safety and the health of our employees can be guaranteed

Die Sicherheit und Gesundheit unserer Mitarbeiter, die Gefahrstoffverordnung GefStofV und die Vorschriften zur Sicherheit am Arbeitsplatz machen es erforderlich, dass dieses Formblatt für alle Produkte, die an uns zurückgeschickt werden, ausgefüllt wird.



Note: A repair is not possible without a completely filled out form.

Ohne Vorliegen des vollständig ausgefüllten Formblattes ist eine Reparatur nicht möglich.

- A completely filled out form must be transmitted via Fax (+49 (0) 7462 2005 93555) or by letter in advance, so that this information is available before the equipment/component part arrives. A second copy of this form must accompany the equipment/component part. In addition, the carrier should be notified.

Eine vollständig ausgefüllte Kopie dieses Formblattes soll per Fax unter Nr. +49 (0) 7462 2005 93555 oder Brief vorab an uns gesandt werden, so dass die Information vorliegt, bevor das Gerät/Bauteil eintrifft. Eine weitere Kopie soll dem Gerät/Bauteil beigelegt sein. Ggf. ist die Spedition zu informieren.

- Incomplete information or non-conformity with this procedure will inevitably lead to substantial delays in processing. Please understand the reason for this measure, which lies outside our area of influence, and will help us to speed up this procedure.

Unvollständige Angaben oder Nichteinhalten dieses Ablaufs führen zwangsläufig zu beträchtlichen Verzögerungen in der Abwicklung. Bitte haben Sie Verständnis für Maßnahmen, die außerhalb unserer Einflussmöglichkeiten liegen und helfen Sie mit, den Ablauf zu beschleunigen.

- **Please print and fill out this form completely**

Bitte unbedingt vollständig ausfüllen!

1.	Unit/ component part / type / Gerät / Bauteil / Typ:
2.	Serial No. / Serien-Nr.:
3.	Details about utilized substances / biological substances / Einzelheiten über die eingesetzten Substanzen/biologische Materialien:
3.1	Designations / Bezeichnungen:
a)	_____
b)	_____
c)	_____
3.2	Safety measures required for handling these substances / Vorsichtsmaßnahmen beim Umgang mit diesen Stoffen:
a)	_____
b)	_____
c)	_____

3.3	Measures to be taken in case of skin contact or release into the atmosphere / Maßnahmen bei Personenkontakt oder Freisetzung: a) _____ b) _____ c) _____ d) _____
3.4	Other important information that must be taken into account / Weitere zu beachtende und wichtige Informationen: a) _____ b) _____ c) _____
4.	Declaration on the risk of these substances (please checkmark the applicable items) / Erklärung zur Gefährlichkeit der Stoffe (bitte Zutreffendes ankreuzen) :
<input type="checkbox"/>	4.1 For non toxic, non radioactive, biologically harmless materials / für nicht giftige, nicht radioaktive, biologisch ungefährliche Stoffe: We hereby guarantee that the above-mentioned unit / component part... / Wir versichern, dass o.g. Gerät/Bauteil... <input type="checkbox"/> Has not been exposed to or contains any toxic or otherwise hazardous substances / weder giftige noch sonstige gefährliche Stoffe enthält oder solche anhaften. <input type="checkbox"/> That eventually generated reaction products are non-toxic and also do not represent a hazard / auch evtl. entstandene Reaktionsprodukte weder giftig sind noch sonst eine Gefährdung darstellen. <input type="checkbox"/> Eventual residues of hazardous substances have been removed / evtl. Rückstände von Gefahrstoffen entfernt wurden.
<input type="checkbox"/>	4.2 For toxic, radioactive, biologically harmful or hazardous substances, or any other hazardous materials / für giftige, radioaktive, biologisch bedenkliche bzw. gefährliche Stoffe oder anderweitig gefährliche Stoffe. We hereby guarantee that ... / Wir versichern, dass ... <input type="checkbox"/> The hazardous substances, which have come into contact with the above-mentioned equipment / component part, have been completely listed under item 3.1 and that all information in this regard is complete / die gefährlichen Stoffe, die mit dem o.g. Gerät/Bauteil in Kontakt kamen, in 3.1 aufgelistet sind und alle Angaben vollständig sind. <input type="checkbox"/> That the unit /component part has not been in contact with radioactivity / das Gerät/Bauteil nicht mit Radioaktivität in Berührung kam
5.	Kind of transport / transporter / Transportweg/Spediteur: Transport by (means and name of transport company, etc.) Versendung durch (Name Spediteur o.ä.) _____ _____ Date of dispatch to BINDER GmbH / Tag der Absendung an BINDER GmbH: _____ _____

We hereby declare that the following measures have been taken / Wir erklären, dass folgende Maßnahmen getroffen wurden:

- Hazardous substances were removed from the unit including component parts, so that no hazard exists for any person in the handling or repair of these items / das Gerät/Bauteil wurde von Gefahrstoffen befreit, so dass bei Handhabung/Reparaturen für die betreffenden Person keinerlei Gefährdung besteht
- The unit was securely packaged and properly identified / das Gerät wurde sicher verpackt und vollständig gekennzeichnet.
- Information about the hazardousness of the shipment (if required) has been provided to the transporter / der Spediteur wurde (falls vorgeschrieben) über die Gefährlichkeit der Sendung informiert.

We hereby commit ourselves and guarantee that we will indemnify BINDER GmbH for all damages that are a consequence of incomplete or incorrect information provided by us, and that we will exempt BINDER GmbH from eventual damage claims by third parties. / Wir versichern, dass wir gegenüber BINDER für jeden Schaden, der durch unvollständige und unrichtige Angaben entsteht, haften und BINDER gegen eventuell entstehende Schadensansprüche Dritter freistellen.

We are aware that, in accordance with Article 823 of the German Civil Code (BGB), we are directly liable with regard to third parties, in this instance especially the employees of BINDER GmbH, who have been entrusted with the handling / repair of the unit / component. / Es ist uns bekannt, dass wir gegenüber Dritten – hier insbesondere mit der Handhabung/Reparatur des Geräts/des Bauteils betraute Mitarbeiter der Firma BINDER – gemäß §823 BGB direkt haften

Name: _____

Position/ Title: _____

Date / Datum: _____

Signature / Unterschrift: _____

Company stamp / Firmenstempel:



Equipment that is returned to the factory for repair must be accompanied by a completely filled out contamination clearance certificate. For service and maintenance on site, such a contamination clearance certificate must be submitted to the service technician before the start of any work. No repair or maintenance of the equipment is possible, without a properly filled out contamination clearance certificate.

18.2 For chambers located in USA and Canada

Product Return Authorization Request

Please complete this form and the Customer Decontamination Declaration (next 2 pages) and attach the required pictures. E-mail to: IDL_SalesOrderProcessing_USA@binder-world.com

After we have received and reviewed the complete information we will decide on the issue of a RMA number. Please be aware that size specifications, voltage specifications as well as performance specifications are available on the internet at www.binder-world.us at any time.

Take notice of shipping laws and regulations.

	Please fill:	
Reason for return request	<input type="radio"/> Duplicate order	
	<input type="radio"/> Duplicate shipment	
	<input type="radio"/> Demo	<i>Page one completed by sales</i>
	<input type="radio"/> Power Plug / Voltage	115V / 230 V / 208 V / 240V
	<input type="radio"/> Size does not fit space	
	<input type="radio"/> Transport Damage	Shock watch tripped? (<i>pictures</i>)
	<input type="radio"/> Other (specify below)	

Is there a replacement PO?	<input type="radio"/> Yes <input type="radio"/> No	
<i>If yes -> PO #</i>		
<i>If yes -> Date PO placed</i>		
Purchase order number		
BINDER model number		
BINDER serial number		
Date unit was received		
Was the unit unboxed?	<input type="radio"/> Yes <input type="radio"/> No	
Was the unit plugged in?	<input type="radio"/> Yes <input type="radio"/> No	
Was the unit in operation?	<input type="radio"/> Yes <input type="radio"/> No	
<i>Pictures of unit attached?</i>	<input type="radio"/> Yes <input type="radio"/> No	Pictures have to be attached!
<i>Pictures of Packaging attached?</i>	<input type="radio"/> Yes <input type="radio"/> No	

	Customer Contact Information	Distributor Contact Information
Name		
Company		
Address		
Phone		
E-mail		

Customer (End User) Decontamination Declaration

Health and Hazard Safety declaration

To protect the health of our employees and the safety at the workplace, we require that this form is completed by the user for all products and parts that are returned to us. (Distributors or Service Organizations cannot sign this form)



NO RMA number will be issued without a completed form. Products or parts returned to our NY warehouse without an RMA number will be refused at the dock.

A second copy of the completed form must be attached to the outside of the shipping box.

1.	Unit/ component part / type:
2.	Serial No.
3.	List any exposure to hazardous liquids, gasses or substances and radioactive material
3.1	List with MSDS sheets attached where available or needed (if there is not enough space available below, please attach a page):
a)	_____
b)	_____
c)	_____
3.2	Safety measures required for handling the list under 3.1
a)	_____
b)	_____
c)	_____
3.3	Measures to be taken in case of skin contact or release into the atmosphere:
a)	_____
b)	_____
c)	_____
d)	_____
3.4	Other important information that must be considered:
a)	_____
b)	_____
c)	_____

4. Declaration of Decontamination

For toxic, radioactive, biologically and chemically harmful or hazardous substances, or any other hazardous materials.

We hereby guarantee that

- 4.1 Any hazardous substances, which have come into contact with the above-mentioned equipment / component part, have been completely listed under item 3.1 and that all information in this regard is complete.
- 4.2 That the unit /component part has not been in contact with radioactivity
- 4.3 Any Hazardous substances were removed from the unit / component part, so that no hazard exists for a person in the shipping, handling or repair of these returned unit
- 4.4 The unit was securely packaged in the original undamaged packaging and properly identified on the outside of the packaging material with the unit designation, the RMA number and a copy of this declaration.
- 4.5 Shipping laws and regulations have not been violated.

I hereby commit and guarantee that we will indemnify BINDER Inc. for all damages that are a consequence of incomplete or incorrect information provided by us, and that we will indemnify and hold harmless BINDER Inc. from eventual damage claims by third parties.

Name: _____

Position: _____

Company: _____

Address: _____

Phone #: _____

Email: _____

Date: _____

Signature: _____



Equipment returned to the NY warehouse for repair must be accompanied by a completed customer decontamination declaration. For service and maintenance works on site, such a customer decontamination declaration must be submitted to the service technician before the start of work. No repair or maintenance of the equipment is possible without a completed form.

